

MHI
Copy 3

FM 8-35

WAR DEPARTMENT FIELD MANUAL

**TRANSPORTATION
OF THE SICK AND
WOUNDED**

WAR DEPARTMENT . FEBRUARY 1945

WAR DEPARTMENT FIELD MANUAL
FM 8-35

*This manual supersedes FM 8-35, 21 February 1941, including C1, 8 June 1943,
C2, 4 November 1943, C3, 13 April 1944, and C4, 17 August 1944.*

TRANSPORTATION
OF THE SICK AND
WOUNDED



WAR DEPARTMENT • FEBRUARY 1945

For Sale by the Superintendent of Documents, Washington, D. C.

*United States Government Printing Office
Washington: 1945*

WAR DEPARTMENT
Washington 25, D. C., 28 February 1945

FM 8-35, Transportation of the Sick and Wounded, is published for the information and guidance of all concerned.

[AG 300.7 (1 Dec. 44)]

BY ORDER OF THE SECRETARY OF WAR:

OFFICIAL:

J. A. ULIO
Major General
The Adjutant General

G. C. MARSHALL
Chief of Staff

DISTRIBUTION:

OSW(1); OUSW(1); CofS(1); ACofS(1); AAF(10); AGF(10); ASF(2); T of Opns(5); AAF Comds(2); Arm & Sv Bd(2); Def Comd(Hq)(2), (Surg)(2); Tech Sv(Hq)(2), (Tng Div)(4) except 8(Tng Div)(50); SvC(Hq)(2), (Surg)(2), (Dir of Tng)(2); Class I, II, III, & IV instal(1); Div Eng(2); GH(12); RH(12); Conv H(4); SH(2); Gen Disp(CZ & ZI)(6); Gen & Sp Sv Sch(12); USMA(25); ASTU(2) except 8(12); ROTC(1); OCS 8(1,000); EM Techn Sch 8(30); ASF Tng C(10); AAF Redist Cen(Surg)(6); Labs 8(6); A(Hq)(5), (Surg)(12); CHQ(Hq)(5), (Surg)(12); D(Hq)(6), (Surg)(12); B(Hq)(6), (Surg)(12); R(Hq)(4), (Surg)(6); Bn(Hq)(2) except 8(Hq)(3), (Surg)(4) except 7(Surg)(6); C(2) except 8(8); AF(Hq)(5), (Surg)(12); W(Hq)(2), (Surg)(6); G(Hq)(4), (Surg)(6); S(Hq)(2), (Surg)(2); F(1). T/O & E: 8-447(6); 8-500(Hq)(50); 8-510(8); 8-520(6); 8-534(2); 8-537T(4); 8-572(5); 8-580(8); 8-581(8); 8-590(4); 8-591T(4); 8-595T(4); 8-750(2); 8-760(2); 8-790(2); 55-110-1(2).

For explanation of symbols, see FM 21-6.

FOREWORD

PURPOSE AND SCOPE. The purpose of this manual is to describe methods and means by which the sick and wounded may be transported. It includes a description of the common methods and means of transporting patients on land, sea, and in the air, and is appropriately illustrated. The *principles* of evacuation and the *responsibility* therefor are discussed in FM 8-5 and 8-10.

RELATION OF TRANSPORTATION TO THE MEDICAL TASK. One of the chief responsibilities of the medical service is the evacuation of sick and wounded. Evacuation includes the collection of casualties on the battlefield and their subsequent movement through the various medical installations from aid station to general hospital. Prompt and orderly evacuation of casualties from forward areas, in a manner least likely to interfere with other military requirements, allows combat units to preserve their mobility and promotes the morale of the remaining effective troops. Evacuation must be continuous and must be carried out with all speed possible without endangering life or limb. The transport employed in this movement will be determined by the particular conditions existing in various stages of the journey. When necessary, means of transport must be improvised.

CONTENTS

	<i>Paragraphs</i>	<i>Page</i>
CHAPTER 1. MANUAL TRANSPORTATION		
<i>Section I.</i> General	1	1
<i>II.</i> One-man carries	2- 10	1
<i>III.</i> Two-man carries	11- 16	22
CHAPTER 2. LITTER TRANSPORTATION		
<i>Section I.</i> General	17- 18	34
<i>II.</i> Types of litters	19- 27	35
<i>III.</i> Introduction in the use of the litter	28- 53	52
<i>IV.</i> Dressing the litter	54- 57	89
<i>V.</i> Litter obstacles	58- 67	92
<i>VI.</i> Improvised litters	68- 73	105
CHAPTER 3. AIDS IN LITTER TRANSPORTATION		
<i>Section I.</i> Types of aids	74- 79	111
<i>II.</i> Instruction in the use of the wheeled litter carrier	80- 82	123
CHAPTER 4. MOTOR AMBULANCE TRANSPORTATION		
<i>Section I.</i> General	83- 86	132
<i>II.</i> Instruction in ambulance loading and unloading	87- 89	137
CHAPTER 5. CONVERSION OF COMMON MILITARY VEHICLES TO PATIENT CARRIERS	90- 97	156
CHAPTER 6. RAIL TRANSPORTATION	98-100	178
CHAPTER 7. AIR TRANSPORTATION	101-107	188
CHAPTER 8. WATER TRANSPORTATION	108-113	207

This manual supersedes FM 8-35, 21 February 1941, including C1, 8 June 1943, C2, 4 November 1943, C3, 13 April 1944, and C4, 17 August 1944.

CHAPTER 1

MANUAL TRANSPORTATION

Section I. GENERAL

1. **GENERAL.** Knowledge of the correct methods of transporting seriously injured persons is one of the most important parts of first aid or emergency medical treatment. Careless or rough handling not only may increase the seriousness of an injury, but may result even in death. Unless there is a good reason for moving an injured person immediately, do *not* transport him until medical facilities, such as a litter or an ambulance, are available. Sometimes, when the situation is urgent and you know that no medical facilities are available, you will have to move the victim yourself. For these cases you must know the different methods of manual transportation of casualties. Always give whatever first aid or treatment is needed before attempting to move the wounded soldier. If the casualty has a broken bone, never move him until you have immobilized the injured part by splinting. Following are many ways by which you can carry a wounded man both with and without help. If another man is present to help you, use one of the two-man carries that are discussed. Two-man carries are more comfortable for the victim, will enable you to carry him farther, and are less likely to aggravate fractures or other serious injury.

Section II. ONE-MAN CARRIES

2. **FIREMAN'S CARRY.** The fireman's carry is one of the easiest methods for one man to carry the entire weight of another. It may be used for an unconscious

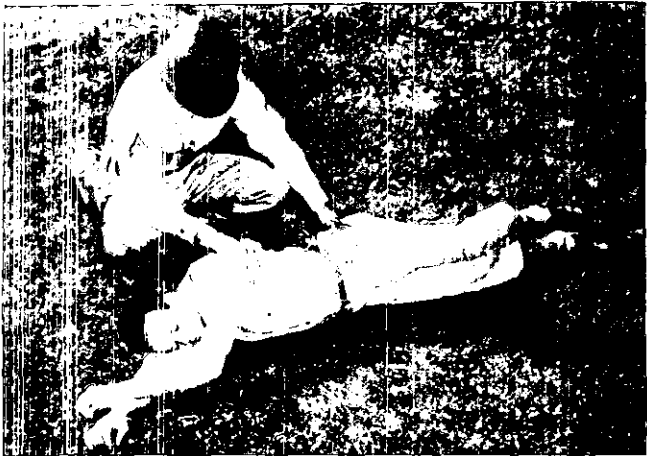

Figure 1. Fireman's carry; first step. Turn victim face down on ground.



Figure 2. Fireman's carry; second step. Support victim's head on his arm.



Figure 3. Fireman's carry; third step. Straddle victim and lift him to standing position by placing your hands under his armpits.

person. Mastery of this carry is of special importance, as the preliminary steps of the fireman's carry are used in many other one-man carries. You can always raise an unconscious or disabled person from the ground in the manner illustrated in the first three steps of the fireman's carry. After moving the victim to an upright position, you may use any of several other one-man carries to transport him.



Figure 4. Fireman's carry; fourth step. Support victim by arm around his waist and move to his front.

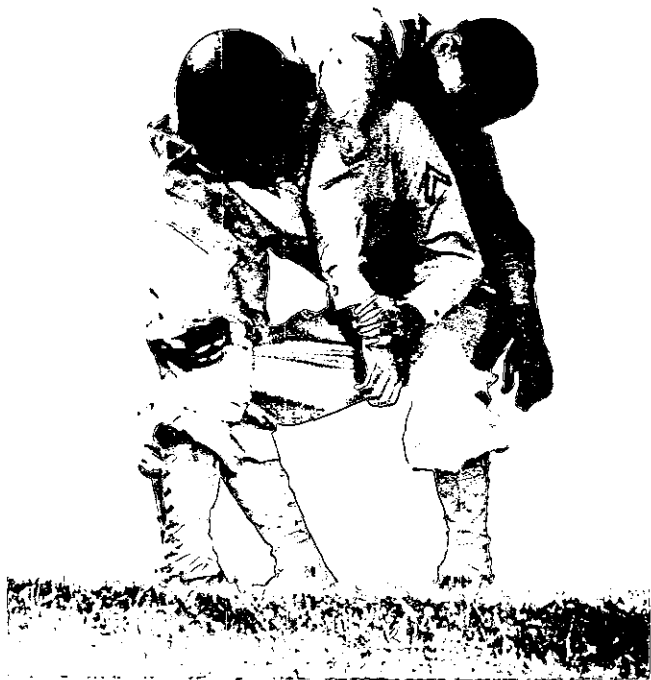

Figure 5. Fireman's carry; fifth step. Grasp the victim's right hand with your left and bend at the waist, pulling the victim's right arm around the back of your neck as you do so. Pull down the victim's right arm so that his body comes across your back. Grasp his legs at the knees with your right arm.



Figure 6. Fireman's carry; sixth step. Lift victim off the ground as you straighten up, holding his right wrist in your left hand and his knees in your right hand.



Figure 7. Fireman's carry; seventh step. Then grasp the victim's right hand, leaving your left hand free. This is the position of carry. A man can carry another some distance in this manner.

3. **SUPPORTING CARRY** (fig. 8). After raising the victim from the ground (as in the fireman's carry), seize his left (right) wrist with your left (right) hand and draw his arm around your neck. The victim is thus able to walk, using you as a crutch. This carry is useful when the victim is only slightly hurt, such as in foot and ankle injuries.



Figure 8. Supporting carry.

4. **ARMS CARRY** (fig. 9). This is a good method for carrying an injured person short distances. Carry the patient high to lessen fatigue. Never use this carry when the victim has a broken back or leg.

5. **SADDLE-BACK CARRY** (fig. 10). Having raised the victim to an upright position, maintain a pull on his arm and step in front of him. Then stoop and raise him upon your back. Have the patient encircle your neck with his arms, and clasp your hands beneath his thighs.



Figure 9. Arms carry.



Figure 10. Saddle-back carry.



Figure 11. Pack-strap carry.

6. PACK-STRAP CARRY (fig. 11). After raising victim from the ground, step in front of him. Grasp his wrists with your hands and hoist him so that his armpits are over your shoulders. This is a good way of carrying an unconscious man, but do not use it if there is a broken bone.



Figure 12. Neck drag.

7. NECK (FIREMAN'S) DRAG (fig. 12). The victim's hands are tied around your neck, enabling you to crawl along, dragging the victim, who may be unconscious. This method has the advantage of permitting both you and the man you are carrying to remain low on the ground, and thus protected, if in battle. *Never attempt to drag a man with a broken neck or back.*

8. PISTOL-BELT CARRY. a. **General.** This carry was adopted from a carry used by Russian women to transport wounded Russian soldiers from the front lines to the rear. It is easily learned, can be accomplished with items of equipment which will always be present with, or on the soldier, and will permit the ordinary soldier to transport a casualty with a considerable degree of comfort for long distances over all types of terrain. Although

this one-man carry is commonly known as the "pistol-belt carry" it can be accomplished with one rifle sling and one pistol belt; two triangular bandages; two litter straps, or any other equipment that will make a loop 2 feet in diameter.

b. After treating the wounds, or splinting the fracture of the injured man in the appropriate manner, link together two pistol belts, or other equipment to form a continuous belt under his thighs and hips so that a loop extends from each side (fig. 13).

c. Lie between the wounded man's extended legs, thrusting your arms through the belt loops. Grasp the wounded man's right (left) hand with your left (right) hand and his right (left) trouser leg with your right (left) hand (fig. 14). Then, rolling toward the uninjured side, turn over to the prone position, carrying the wounded man onto your back. Make necessary adjustments of slings before proceeding (fig. 15).

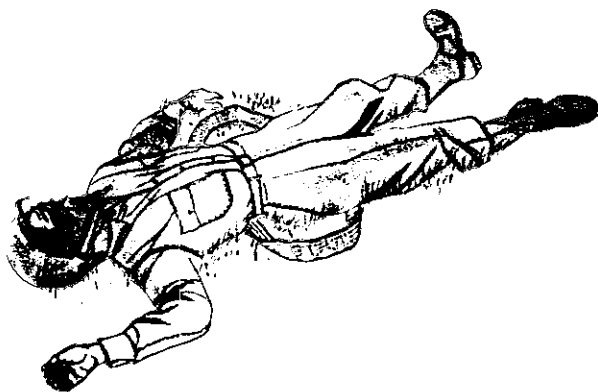

Figure 13. Pistol-belt carry; first step.

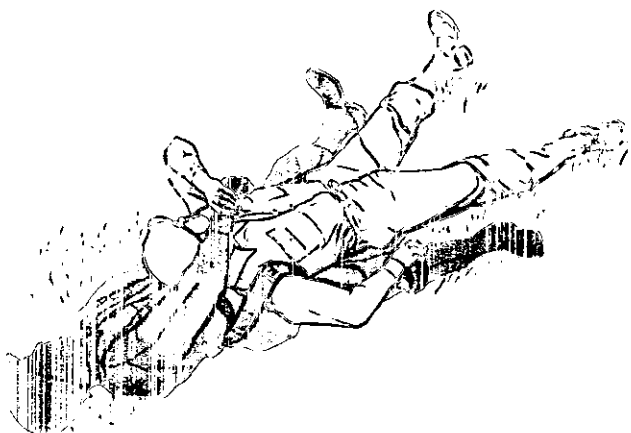

Figure 14. Pistol-belt carry; second step.

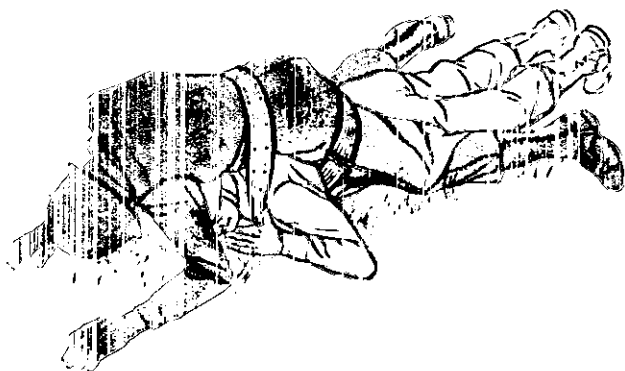

Figure 15. Pistol-belt carry; third step.



Figure 16. Pistol-belt carry; fourth step.

d. Rise to kneeling position. The continuous belt will hold casualty firmly in position (fig. 16).

e. Place one hand on your knee for support then rise to upright position. The patient is now supported on your shoulders and held in position by the continuous belt, and will ride comfortably whether conscious or not (fig. 17)

f. You are now ready to move with your hands and arms unencumbered by the necessity of supporting the patient. You can use your hands to assist you in climbing steep banks or in surmounting all types of obstacles (fig. 18). A strong man can carry another for quite some distance in this manner without undue fatigue. An added advantage of this method is that it permits both bearer and patient, if conscious, to fire rifles. In certain cases it may be substituted for litters in rough or mountainous terrain, and can easily be used as a method for carrying equipment.



Figure 17. Pistol-belt carry; final step.



Figure 18. Pistol-belt carry being used over difficult terrain.

9. PISTOL-BELT DRAG. Extend two pistol belts or similar objects their full length and join together to make one continuous loop. (See fig. 19.) After placing the patient on his back, pass the loop over the patient's head and work it into position across his chest under his armpits. Then cross the belts under the patient's head (fig. 20). Turn around, lying on your abdomen slightly to the patient's side. Slip the loop over your arm and shoulder on the side away from the patient. Then advance by crawling, dragging the patient with you (fig. 21). This carry has the advantage of permitting both bearer and patient to remain on the ground, thus protected from enemy fire, but can be used only for very short distances.

10. BACK LIFT AND CARRY. To use this carry, the patient must be conscious and able to stand on at least



Figure 19. Pistol-belt drag; loop formed from two belts.



Figure 20. Pistol-belt drag; loop in position.



Figure 21. Pistol-belt drag.



Figure 22. Back lift and carry; raising patient.



Figure 23. Back lift and carry; carrying position.

one leg. After raising patient to a standing position, place yourself back to back with him and have him stretch out his arms sideways. Bend down, put your hands under patient's arms, and grip his upper arms (fig. 22). Bend forward, pulling patient onto your back (fig. 23).



Figure 24. Two-man supporting carry.

Section III. TWO-MAN CARRIES

11. **TWO-MAN SUPPORTING CARRY** (fig. 24). This carry is easy and commonly used. The victim may be unconscious, but if he has a broken bone, do not use this method.

12. **TWO-MAN ARMS CARRY**. This carry is particularly suited to lifting a patient onto a litter or other carrier.



Figure 25. Two-man arms carry; first step. Bearers slide arms under patient.



Figure 26. Two-man arms carry; second step. Bearers lift patient to their knees.



Figure 27. Two-man arms carry; third step. Bearers rise lifting patient to their chests.



*Figure 28. Two-man saddle-back carry; first step.
Bearers in position ready to lift.*

a. First step (fig. 25). Bearers kneel at patient's side. One bearer places one arm beneath the patient's shoulders, and the other arm beneath his back. The second bearer places his arms beneath the patient's hips and knees.

b. Second step (fig. 26). Bearers lift patient to their knees.

c. Third step (fig. 27). Bearers rise together, lifting the patient to their chests. Carrying the patient well up helps lessen fatigue.

13. TWO-MAN SADDLE-BACK CARRY. This is a good method of carrying an unconscious person a short distance. It should never be used if the injured person has a fracture.



Figure 29. Two-man saddle-back carry.

a. **First step** (fig. 28). With the patient on his back, the front bearer spreads the patient's legs, steps between them, kneels, and grasps the patient's thighs. The rear bearer kneels at the patient's head and thrusts his arms through the patient's armpits and across his chest.

b. **Second step** (fig. 29). Bearers rise together, lifting the patient.

14. **FOUR-HAND CARRY (PACK-SADDLE CARRY).**



Figure 30. Four-hand carry; position of hands.

This is a good carry for injuries of the head or feet. The patient must be conscious so that he can hold on.

a. **First step** (fig. 30). Each bearer grasps his own left wrist with his right hand, and then grasps the other bearer's right wrist with his left hand.

b. **Second step** (fig. 31). The patient then sits on the interlocked hands of the bearers, supporting himself by placing an arm around each of their necks.



Figure 31. Four-hand carry.

15. TWO-HAND CARRY. If the patient is unconscious, a modification of the pack-saddle carry may be used.



Figure 32. Two-hand carry. Position of hands under patient.



Figure 33. Two-hand carry; rear view.

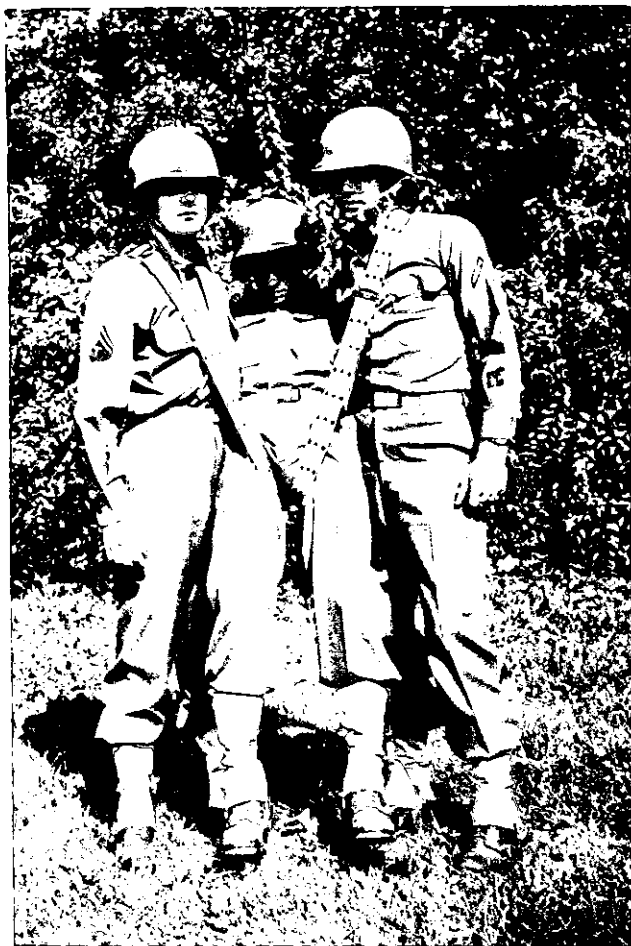

Figure 34. Double-loop pistol-belt carry.



Figure 35. Wounded American soldiers returning from front line in New Guinea. Note use of saddle back carry.

Bearers pass their front (outer) arms under patient's thighs and grasp each other's wrists. (See fig. 32.)

a. Patient is raised and supported in an upright position.

b. As the patient sits on the seat thus formed, bearers grip each others back (inner) arms under patient's arms and behind his back (fig. 33) and proceed.

16. DOUBLE LOOP-PISTOL BELT CARRY. Four pistol belts (or similar objects) are required for this carry. Two closed loops are formed of two belts each. The patient's legs are then passed one through each loop. (See fig. 34.) Bearers put the loops over their right and left shoulders respectively, raise patient, and proceed.

CHAPTER 2

LITTER TRANSPORTATION

Section I. GENERAL

17. **DEFINITIONS.** a. **Litter.** A litter is a device capable of being carried by two or more bearers for the purpose of transporting sick, injured, or dead persons.

b. **Types of cases.** (1) *Walking.* All sick and wounded patients who are able to walk from the place where they became casualties to the medical installation designed for their treatment, without aggravating their condition, are classified as walking (or ambulant) cases.

(2) *Litter.* All patients who are unable to walk either with or without assistance, or whose condition might be aggravated by walking, are classified as litter (or recumbent) cases. All litter cases, regardless of whether they occur in posts, camps, or on the battlefield, will require more or less movement on a Medical Department litter or on an improvised substitute.

18. **REQUISITES OF MILITARY LITTER.** For satisfactory employment in the military service, a litter should fulfill the following requirements:

a. **Size.** The size of the litter must be sufficient to accommodate individuals whose height and weight are within the maximum limits as prescribed by the War Department.

b. **Weight.** The weight should be as light as possible without sacrificing necessary strength and durability.

c. **Durability.** The durability should be sufficient to withstand the rough usage encountered in prolonged field operations.

d. **Type.** It is desirable that the litter be collapsible in at least one axis to facilitate handling, storage, and movement to the point of use.

e. **Standardization.** It is also desirable that all litters possess the same dimensions when open. This allows the patient to pass through the various echelons of medical service without being removed from the litter upon which he is originally placed, even though the evacuation journey involves the use of several different types of carriers. Such standardization will result in the saving of valuable time and obviate the danger to the patient resulting from changing litters. Standardization is highly desirable not only throughout the military service but also between the military and naval services to facilitate evacuation during joint operations. (See FM 8-25.)

Section II. TYPES OF LITTERS

19. LITTERS EMPLOYED BY MEDICAL DEPARTMENT. There are several different types of litters used by the Medical Department. These types have been adopted because of the availability of certain materials to the manufacturers, and the necessity of designing special litters to meet special situations.

20. STRAIGHT ALUMINUM LITTER.

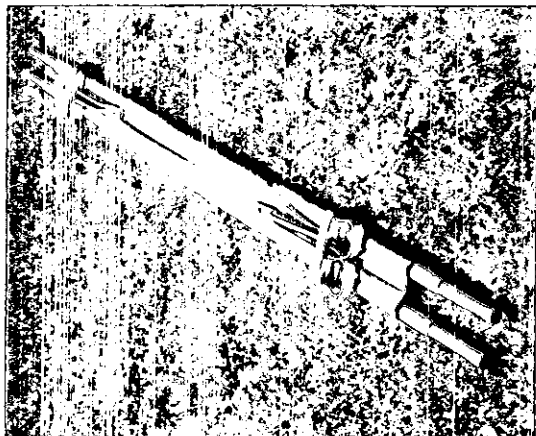

③ Closed and strapped.

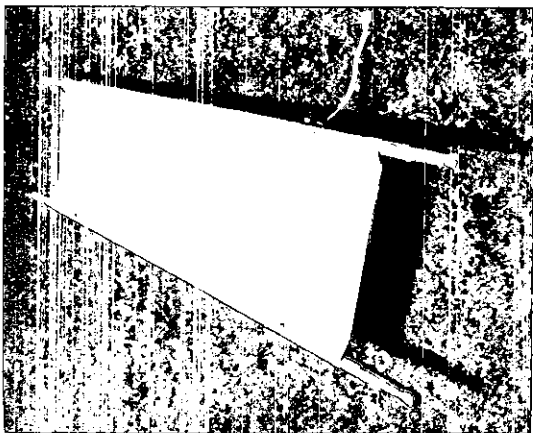

① Open.

Figure 36. Straight aluminum litter.

SPECIFICATIONS:

Length:	90 inches (over-all).
Width:	22 $\frac{7}{8}$ inches.
Weight:	15 pounds.
Bed:	Canvas, 6 feet long, 22 $\frac{7}{8}$ inches wide.
Poles:	Aluminum alloy, 1.54 inches in diameter, 77 inches long.
Handles:	Wooden, 6 $\frac{1}{2}$ inches long.
Stirrups:	3 $\frac{3}{8}$ inches wide, 4 $\frac{5}{16}$ inches high, with base and swivel blocks, bolted to poles, 22 inches from outer ends of handles.
Spreader bars:	Extend crosswise at stirrups to hold canvas taut when litter is open.
Accessories:	Two 16 $\frac{1}{2}$ -inch lengths of 1-inch web strap, affixed one to each pole at the stirrup bolts, to strap the collapsed litter.
Advantages:	Light weight; high degree of durability; folds in long axis only.

21. FOLDING ALUMINUM LITTER.

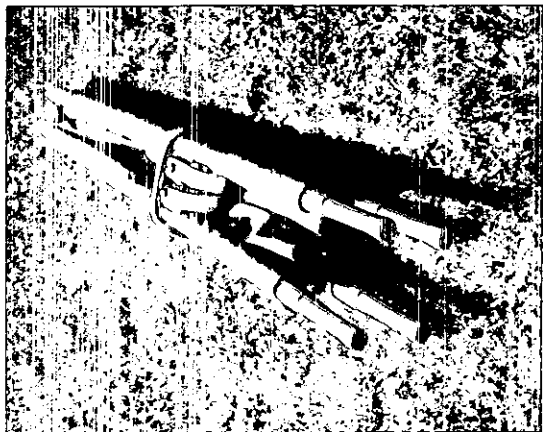

② Closed, folded and strapped.

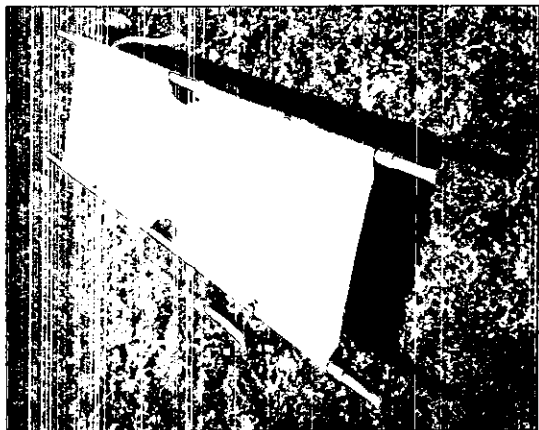

① Open.

Figure 37. Folding aluminum litter.

SPECIFICATIONS:

Length:	90 inches (over-all).
Width:	22 $\frac{7}{8}$ inches.
Weight:	18 $\frac{3}{4}$ pounds.
Bed:	Canvas; 6 feet long, 22 $\frac{7}{8}$ inches wide.
Poles:	Aluminum alloy, 1.54 inches in diameter, 77 inches long; jointed at the mid-point.
Handles:	Wooden, 6 $\frac{1}{2}$ inches long.
Stirrups:	3 $\frac{5}{8}$ inches wide, 4 $\frac{9}{10}$ inches high, with base and swivel blocks, bolted to poles, 22 inches from outer ends of handles.
Spreader bars:	Extend crosswise at stirrup to hold canvas taut when litter is open.
Accessories:	Two 16 $\frac{1}{2}$ -inch lengths of 1-inch web strap, affixed one to each pole at the stirrup bolts, to strap the collapsed litter.
Advantages:	Light weight; high degree of durability; folds in both long and short axes to facilitate storage and handling.

22. STRAIGHT WOOD LITTER.

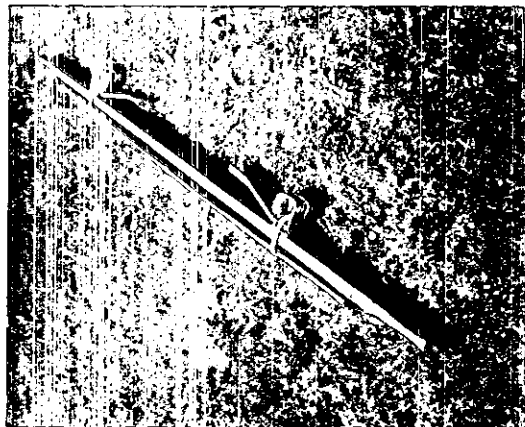

③ Closed and strapped.

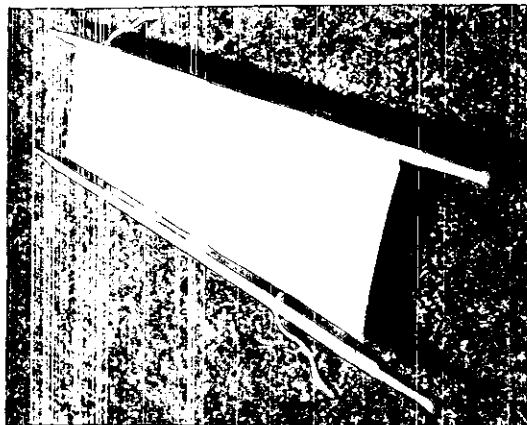

① Open.

Figure 38. Straight wood litter.

SPECIFICATIONS:

- Length:** 90 inches (over-all).
- Width:** 22 $\frac{7}{8}$ inches.
- Weight:** 20 $\frac{1}{4}$ pounds.
- Bed:** Canvas; 6 feet long, 22 $\frac{7}{8}$ inches wide.
- Poles:** Laminated wood (6-ply), 1 $\frac{1}{2}$ by 1 $\frac{1}{2}$ inches, with corners rounded $\frac{1}{8}$ inch; 90 inches in length, including handle.
- Handles:** Pole ends cut to form handles, each 6 inches in length.
- Stirrups:** Steel; 3 $\frac{1}{8}$ inches wide, 4 inches high, with braces; bolted to poles 22 inches from pole ends.
- Spreader bars:** Extend crosswise at stirrups to hold canvas taut when litter is open.
- Accessories:** Two 16 $\frac{1}{2}$ -inch lengths of 1-inch web strap affixed one to each pole at the stirrup bolts, to strap the collapsed litter.
- Advantages:** High degree of durability.

23. FOLDING WOOD LITTER.

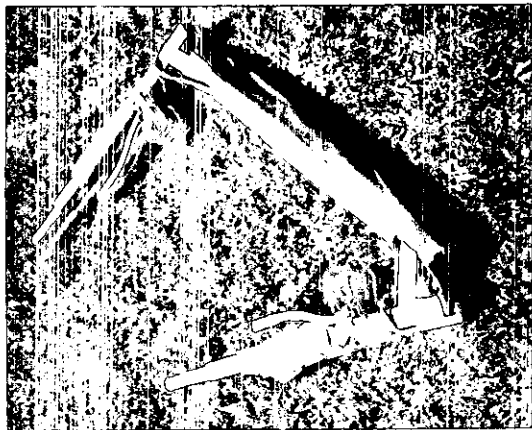

② Closed and partly folded.

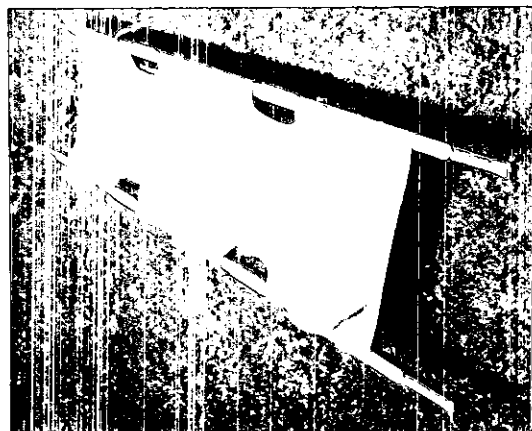

① Open.

Figure 39. Folding wood litter.

SPECIFICATIONS:

- Length:** 90 inches (over-all).
- Width:** 22 inches.
- Weight:** 20 pounds.
- Bed:** Canvas, 72 by 22 $\frac{7}{8}$ inches.
- Poles:** Laminated wood (6-ply), 1 $\frac{1}{2}$ by 1 $\frac{1}{2}$ inches, corners rounded, double-folding, 90 inches in length.
- Handles:** Pole ends cut to form handles, each 6 inches in length.
- Stirrups:** Steel, 3 $\frac{1}{8}$ inches wide, 4 inches high with braces; bolted to poles 22 inches from pole ends.
- Spreader bars:** Extend crosswise at stirrups to hold canvas taut when litter is open.
- Accessories:** Two 16 $\frac{1}{2}$ -inch lengths of 1-inch web strap affixed one to each pole at the stirrup bolts, to strap the collapsed litter.
- Advantages:** Folds once lengthwise and twice crosswise, thus facilitating handling and storage.

24. STRAIGHT STEEL LITTER.

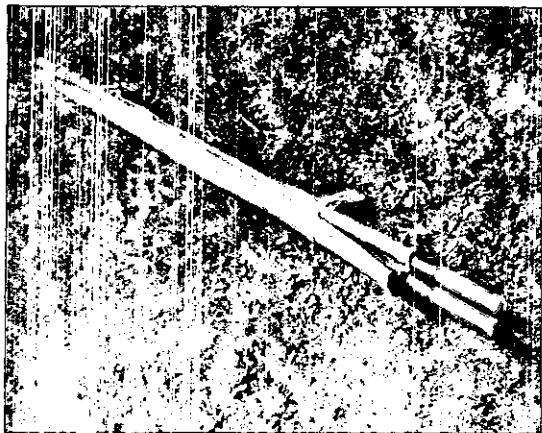

② Closed and strapped.

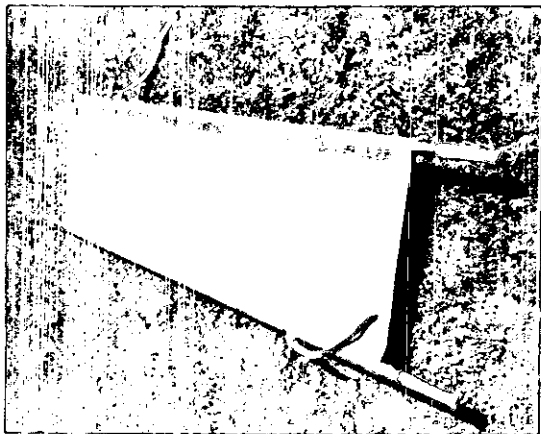

① Open.

Figure 40. Straight steel litter.

SPECIFICATIONS:

Length:	90 inches (over-all).
Width:	21 $\frac{7}{8}$ inches.
Weight:	20 $\frac{1}{4}$ pounds.
Bed:	Canvas, 72 by 21 $\frac{7}{8}$ inches.
Poles:	Tubular steel, 77 inches in length.
Handles:	Wooden, extending 6 $\frac{1}{2}$ inches from ends of poles.
Stirrups:	3 $\frac{1}{2}$ inches wide; 4 inches high, bolted to poles, 15 $\frac{1}{2}$ inches from ends of poles.
Spreader bars:	Extend crosswise at stirrup bolts to hold canvas taut when litter is open.
Accessories:	Two 16 $\frac{1}{2}$ -inch lengths of 1-inch web strap; affixed one to each pole of the stirrup bolts to strap the collapsed litter.
Advantages:	High degree of durability.

25. METAL AIRPLANE LITTER (STOKES).

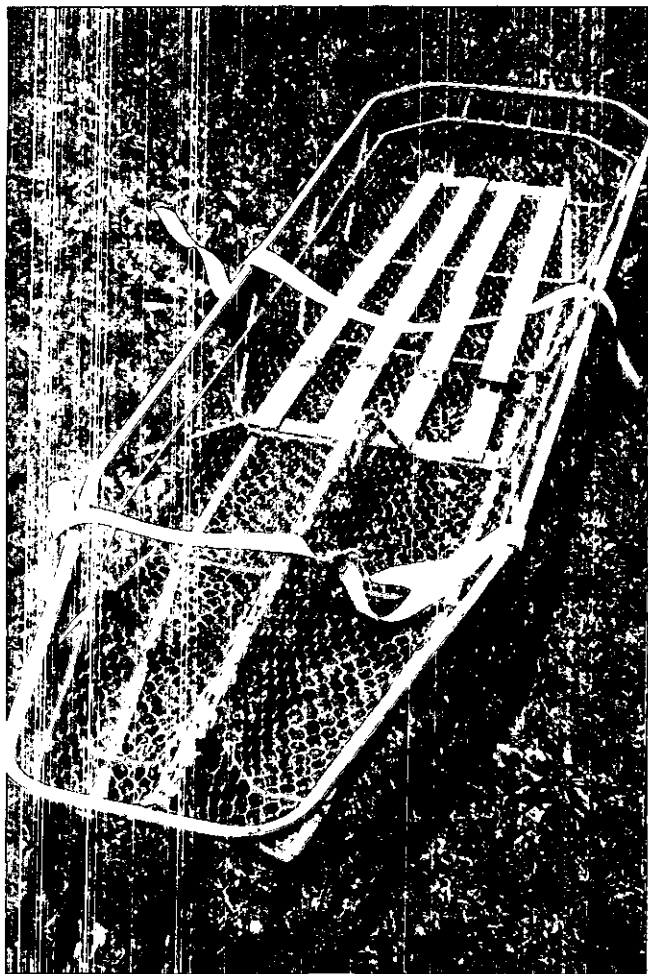

Figure 41. Metal airplane litter (Stokes).

SPECIFICATIONS:

- Length: 7 feet.
Width: 23 inches.
Depth: 8 inches.
Weight: 31½ pounds.
Bed: Wire mesh netting, supported in a rigid frame of steel tubing. Lower half divided into two compartments to accommodate legs of patient.
Accessories: Securing straps at level of chest, thighs (2), and legs.
Advantages: Affords complete security for patient when litter is tilted.
Remarks: Extensively used by the Navy; used in joint operations.

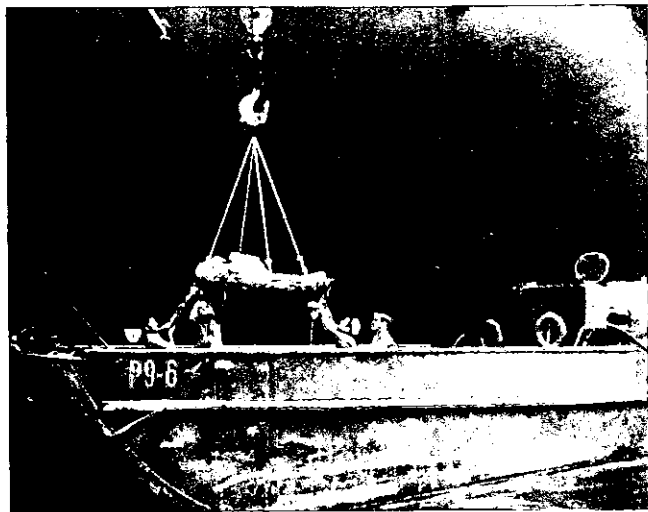

Figure 42. Transferring patient from tank lighter to transport by means of Stokes litter (South Pacific area).

26. AMBULANCE COT LITTER, BOMGARDNER TYPE.

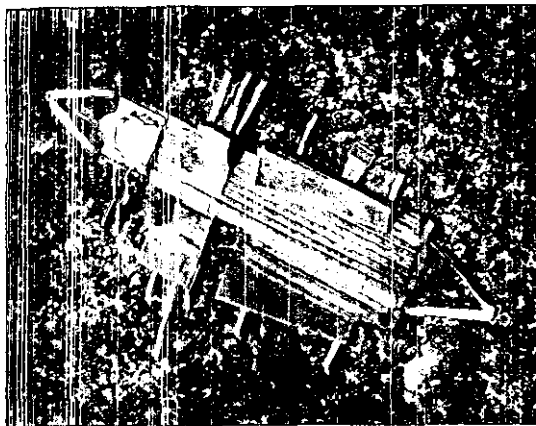

Figure 43. Ambulance cot litter, Borngardner type.

SPECIFICATIONS:

Length:	76 inches.
Width:	20 inches.
Bed:	Rubberized air mattress, supported by steel springs on metal frame; metal adjustable headrest.
Advantages:	Affords comfort for patient. Wheels afford ease of movement.
Remarks:	Designed for use in Metropolitan ambulance. Not used in advance areas.

27. SEMIRIGID CANVAS LITTER.



① Empty.



② In use.

Figure 44. Semirigid canvas litter.

SPECIFICATIONS:

- Length:** 72 inches plus 30 inches with straps.
- Width:** 14 inches.
- Bed:** Semirigid canvas; with wooden supports, running vertically.
- Straps:** 7 securing straps to tie in patient.
- Accessories:** Head piece to support patient's head. Hand-hold loops; two at each end, for four-man carries. Four loops for slipping poles through for carrying purposes.
- Advantages:** Patient held securely in position; movement in vertical direction is facilitated. Especially useful in evacuating from ships and in mountainous areas.
- Remarks:** Designed by Navy Medical Research Institute for use in combined operations.

Section III. INSTRUCTION IN THE USE OF THE LITTER

28. **GENERAL.** a. **Purpose.** The purpose of this section is to provide guides for instructing personnel in methods of handling litters and litter cases. Use of these guides will secure uniformity in the proper methods of performing a highly important function of medical service, and, at the same time, save valuable training time. This "litter drill" is a means to an end and is not intended as a drill in itself.

b. **Scope.** This section includes proper methods of handling, opening, closing, and strapping litter; loading, carrying and unloading of patients; and the actions of bearers upon encountering unusual situations such as obstacles, stairs, and unusual injuries.

c. **Commands.** Although not to be considered a precision drill, certain commands should be utilized to facilitate instruction. The use of these commands in actual operations is not contemplated.

29. **LITTER SQUAD.** a. **Composition.** A litter squad (fig. 45), both for purposes of instruction and for actual field employment, ordinarily consists of four bearers. Fewer are unable to withstand the fatigue of long and frequent carries, except when aided by a wheeled litter carrier or similar device.

b. **Designation of bearers.** During instruction, each bearer will be given a numerical designation. Members of a litter squad, being in line, are numbered consecutively from right to left. No. 1 is the squad leader; in his absence, No. 4 commands; if both Nos. 1 and 4 are absent, No. 3 becomes the squad leader.



Figure 45. Litter squad.

c. Duties in reduced squads. Nos. 3 and 2 being absent, their duties are assumed by Nos. 1 and 4, respectively. No. 1 being absent, No. 4 assumes his duties. In his absence, the duties of No. 4 do not require replacement.

d. Instruction in reduced squads. Under exceptional circumstances, when 2-bearer squads are being instructed, the instruction will be as for Nos. 2 and 3 of the 4-bearer squad.

30. LITTER, CLOSED, FOLDED, AND STRAPPED.

a. Litter, closed. The litter is said to be closed when the two poles are brought into approximation, the canvas evenly and smoothly doubled upon itself.

b. Litter, folded. The litter is said to be folded when, after closing, it is doubled upon itself in the long axis at the hinges provided for that purpose. Some litters have two pairs of hinges. Not all litters can be folded.

c. Litter, strapped. The litter is said to be strapped when, after closing (and folding, if a folding type litter), it is secured by the cross-straps.

INSTRUCTION WITH UNLOADED LITTERS

31. FORMATIONS. **a. Formation for instruction.** Being in its normal formation, to form and align the unit (detachment, platoon, or company) in a single rank for instruction in the litter, appropriate commands from FM 22-5 will be employed. Similarly, following completion of the instruction, to return the unit to its normal formation, appropriate infantry drill commands will be employed.

b. Formation of litter squads. The unit being in single rank facing the front, to form litter squads, the commands are: 1. **BY FOUR**, 2. **COUNT OFF**. At the command **COUNT OFF** all except the right file execute **EYES RIGHT**, and, beginning with the right file, count **ONE, TWO, THREE, FOUR, ONE**, etc.; each man turns his head and eyes to the front as he counts.

c. Designation of squads. Litter squads being formed, to designate squads by number, the commands are: 1. **BY LITTER SQUADS**, 2. **COUNT OFF**. At the command **COUNT OFF No. 1** of each squad except the right squad, executes **EYES RIGHT**, and, beginning on the right, counts, in consecutive order, **ONE, TWO, THREE**, etc., until all have counted. Each No. 1 turns his head and eyes to the front as he counts.

32. PROCUREMENT OF LITTERS. Being in proper



Figure 46. Formation for instruction in the litter.

formation (fig. 46) and litters being available in the immediate vicinity, for each litter squad to procure one litter, the commands are: 1. PROCURE, 2. LITTER. At the command LITTER all No. 3's take one step to the rear (fig. 47), execute RIGHT (LEFT) FACE, as required by the location of the litters, and immediately proceed in column of files by the nearest route to the closed and strapped litters. Each takes one litter, placing it on the right shoulder (par. 34), and all promptly return in reverse order to the rear of the line, (fig. 48), turn, and step into the line in unison, litters at the vertical (fig. 49). Upon arriving in position, No. 3's bring litters to the shoulder (fig. 50). This drill should be supervised by a noncom. It can be executed in double time.

33. RETURN OF LITTERS. Instruction in use of the litter having been completed, to return litters to the place of procurement, the commands are: 1. RETURN, 2. LITTER. This movement is executed in the same manner as PROCURE, LITTER, except that the litters are carried from, instead of to, the squads.



Figure 47. PROCURE, LITTER; first step. All No. 3 men take one step to rear.



Figure 48. No. 3's halted in rear of line after procuring litters.

34. LITTER AT THE SHOULDER (fig. 51). In the position "at the shoulder," the litter is held at a 45° angle upon the right shoulder with the canvas down, the right hand grasping the lower right stirrup and the left

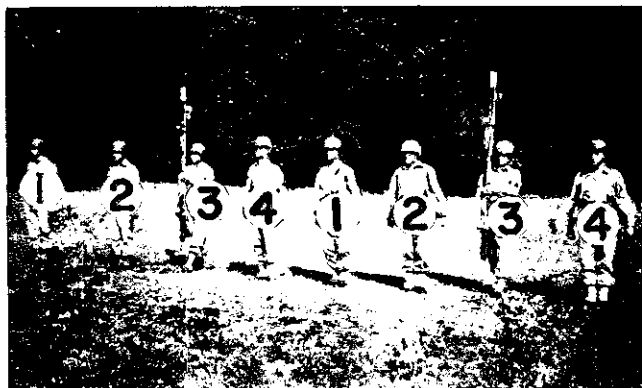

Figure 49. No. 3's step into line, litters vertical.

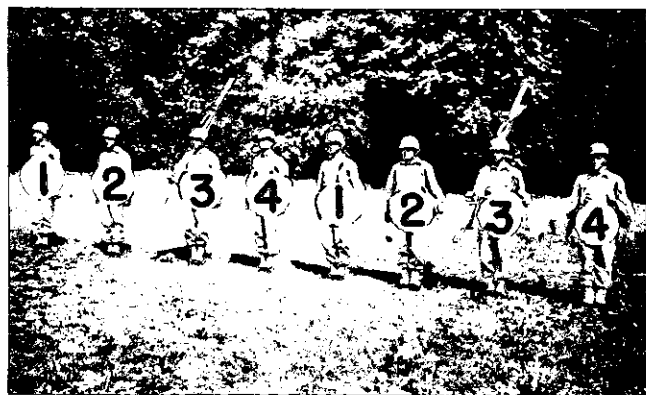

Figure 50. The command PROCURE, LITTER, completed.

hand dropped to the side. In all motions from or to the shoulder, the litter should be brought to the vertical position against the right shoulder, canvas to the rear, right hand grasping the right lower stirrup, and left forearm horizontal with the left hand steadying the litter



Figure 51. Litter at the shoulder.



Figure 52. Litter at the vertical.

against the shoulder (fig. 52). The vertical position should be taken automatically by the bearer when resuming his place in line and in any formation or movement in which there may be danger of the handles of the litter striking nearby individuals, after which "at the shoulder" is resumed without command.



Figure 53. Litter at the order.

35. **TO ORDER LITTER** (fig. 53). Being at the shoulder, to order litter, the commands are: 1. **ORDER**, 2. **LITTER**. At the command **LITTER**, the litter is brought to the vertical position, the lower handles then dropped to the ground outside the right foot, with the canvas



Figure 54. SHOULDER, LITTER; first step.

to the rear. The right arm is extended naturally, with the right hand grasping the poles, and the left hand dropped to the side.

36. TO SHOULDER LITTER. a. From the order. Being at the order, to shoulder litter, the commands are:

1. SHOULDER, 2. LITTER. At the command of execution, the litter is lifted with the left hand (fig. 54) to the vertical position (fig. 52), and then raised until the left wrist is level with the chin. The litter is then laid canvas down upon the shoulder as described in par. 34 (fig. 51).

b. From the carry. Being at the carry (par. 37). to shoulder litter, at the command, No. 3 advances to his former position in line, at the same time bringing the litter to the vertical, and then to the shoulder position. In this he is aided by No. 2 who lifts his end of the litter to the vertical as he steps backward into his former position in line. Nos. 1 and 4 stand fast.

37. TO CARRY LITTER. a. Being in line. Being in line, litters at the shoulder, to carry litter the commands are: 1. CARRY, 2. LITTER. At the command of execution No. 3 brings his litter to the vertical position, takes two steps backward (fig. 55), drops the upper handles forward and downward until the litter is in horizontal position with the canvas up, and grasps the outside handle with his right hand. Meanwhile, No. 2



Figure 55. CARRY, LITTER from shoulder; first step.

steps to the front until he is opposite the front handles, when he grasps the outside handle with his left hand; Nos. 1 and 4 stand fast (fig. 56); guides, if any, align on Nos. 1 and 4.



Figure 56. CARRY, LITTER from shoulder; completed.

b. Being at the ground. The litter being at the ground, to carry litter, at that command, Nos. 3 and 2, using their right and left hands, respectively, stoop, grasp the outside handles (fig. 57), and raise the litter from the ground to the carry.

c. Designation of litter ends. That portion of the litter normally supported by No. 2 is the foot or front; that by No. 3, the head. With the exception of a few special movements, such as carrying patients up or down an incline, the same designation of loaded and unloaded litters applies. Furthermore, the feet of the patient normally correspond to the foot of the litter.

d. Unloaded litter in marching. In marching, the litter is usually at the carry, but when space permits or squads are working independently, it may be at the shoulder.



Figure 57. CARRY, LITTER from ground; first step.

38. TO GROUND LITTER (fig. 58). Being at the carry, to ground litter, the commands are: 1. GROUND, 2. LITTER. At the command LITTER Nos. 3 and 2 stoop and lower litter to the ground, canvas up, release the handles, and resume erect position, facing front.



Figure 58. Litter at the ground.

39. TO CHANGE BEARERS. a. Being at the carry. Being at the carry, in marching, to change bearers, the commands are: 1. CHANGE BEARERS, 2. MARCH. At the command MARCH, Nos. 1 and 4 step to the right rear and left front of the litter respectively, and grasp the handles beside those relinquished by Nos. 2 and 3. Nos. 2 and 3 assume the positions vacated by Nos. 1 and 4, respectively.

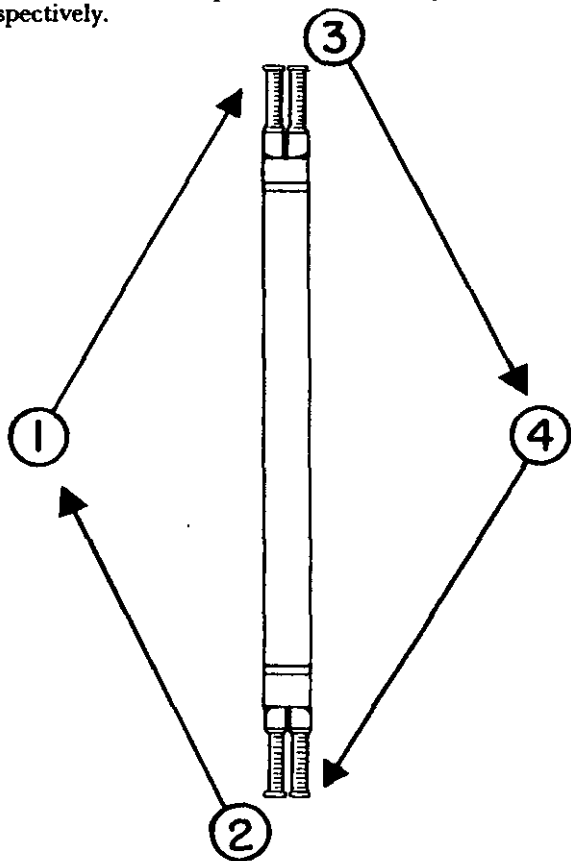

Figure 59. CHANGE BEARERS, MARCH.

b. Being at the ground, closed. The litter being at the ground, closed, to execute **CHANGE BEARERS**, bearers change positions as at the carry, but Nos. 1 and 4 do not grasp the handles.

c. Being at the ground, open. The litter being at the ground, open, to execute the same command, Nos. 1 and 4 assume the rear and front posts, respectively, while Nos. 2 and 3 assume right and left posts respectively, thus all describing part of a circle in a clockwise direction around the litter.

40. TO OPEN LITTER. Being at the carry, litter strapped, to open litter, the commands are: 1. **OPEN**, 2. **LITTER**.

a. First step (fig. 60). At the command **LITTER**, all bearers face the litter.

b. Second step (fig. 61). No. 4 supports the litter at the center, canvas up. Nos. 2 and 3 unfasten straps.

c. Third step (fig. 62). Nos. 2 and 3 grasp the left handles with their right and left hands respectively, leaving the litter suspended longitudinally, canvas to the right.

d. Fourth step (fig. 63). No. 1 extends the braces by kicking.

e. Fifth step. Nos. 2 and 3 each grasp both handles at each end, support the litter horizontally, canvas up, and lower it to the ground. All men return to their positions at litter posts.

41. TO CLOSE LITTER. Being open, to close litter, the commands are: 1. **CLOSE**, 2. **LITTER**. At the command of execution, Nos. 2 and 3 step outside the right front and left rear handles respectively, and face inward. They stoop and, with their right hands, raise the litter by the left handles. No. 4 then collapses the braces by kicking, Nos. 2 and 3 raise the lower pole against the upper, and bring the litter to the position of carry.



Figure 60. OPEN, LITTER; bearers face litter.



Figure 61. OPEN, LITTER; No. 4 supports the litter while Nos. 2 and 3 unfasten straps.

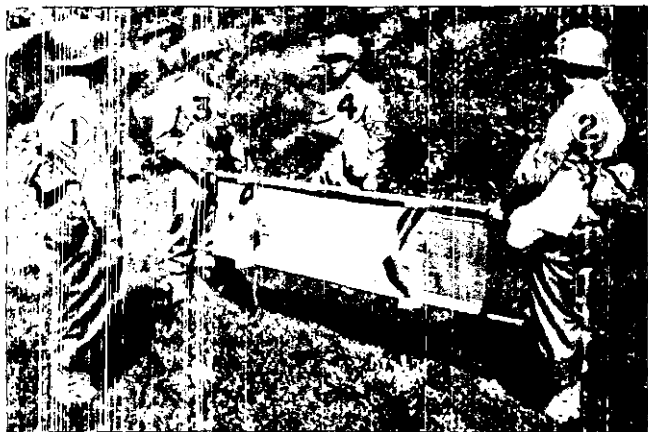

Figure 62. OPEN, LITTER; Nos. 2 and 3 grasp left handles with right and left hands respectively.



Figure 63. OPEN, LITTER; No. 1 extends braces by kicking them open.



*Figure 64. STRAP, LITTER; all men face the litter—
No. 4 supports it at center.*

42. TO STRAP LITTER. The litter being closed, to strap litter, the commands are: 1. STRAP, 2. LITTER.

a. **First step** (fig. 64). At the command of execution all face the litter. No. 4 supports the litter at the center.

b. **Second step** (fig. 65). Nos. 2 and 3, assisted by No. 1 fold canvas by doubling it smoothly on top of the poles.

c. **Third step** (fig. 66). Nos. 2 and 3 secure the folded canvas and poles by fastening the cross straps at each end, and all bearers resume their posts at the carry. In the field, the litter should be carried closed and strapped, and opened only upon reaching the patient. If the litter



Figure 65. STRAP, LITTER; Nos. 2 and 3 fold the canvas assisted by No. 1.

is open, it may be closed and strapped at the one command **STRAP, LITTER**, in which case the procedures outlined are both executed in proper order.

43. TO BRING LITTER SQUAD INTO LINE. During litter instruction it may be desired to move the squad, without litter, to another point. Bearers being at posts with litter at the ground, to bring the squad into line, the commands are: 1. **FORM**, 2. **RANK**. At the command **RANK** No. 2 advances one pace and remaining bearers move forward and align themselves on him, in regular order (fig. 67).

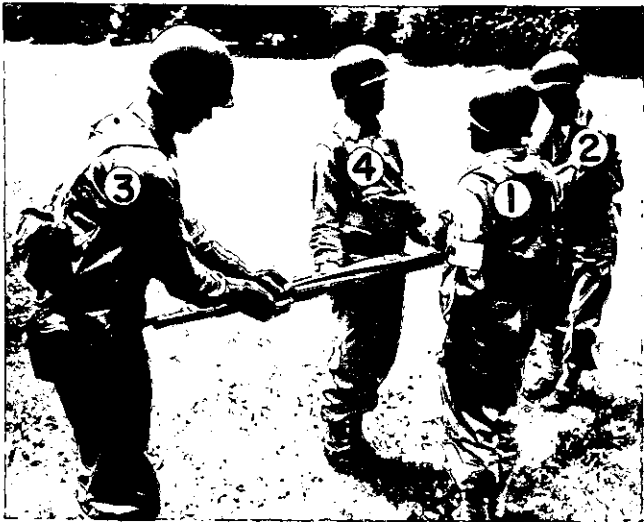

Figure 66. STRAP, LITTER; Nos. 2 and 3 fasten the cross-straps.



Figure 67. Squad in FORM, RANK.

44. TO RESUME LITTER POSTS. Normal bearer posts, with the litter at the ground, may be recovered at any time by the commands: 1. **LITTER**, 2. **POSTS**. At the command **POSTS**, all members of the squad move by the nearest route and resume posts as shown in figure 58.

45. TO LIFT OPEN LITTER, LOADED OR UNLOADED. The litter being at the ground with bearers at litter posts, to lift the litter utilizing the medical soldier's litter-carrying straps, the commands are: 1. **PREPARE TO LIFT**, 2. **LIFT**. At the first command, Nos. 2 and 3 remove their litter-carrying straps from their pouches (par. 75), attach them to their suspenders, then stoop and grasp handles firmly. Meanwhile, Nos. 1 and 4 face the litter, stoop, and grasp the adjacent pole (fig. 68). At the command **LIFT**, Nos. 2 and 3 arise slowly, assisted in lifting by Nos. 1 and 4. Finally Nos. 1 and 4

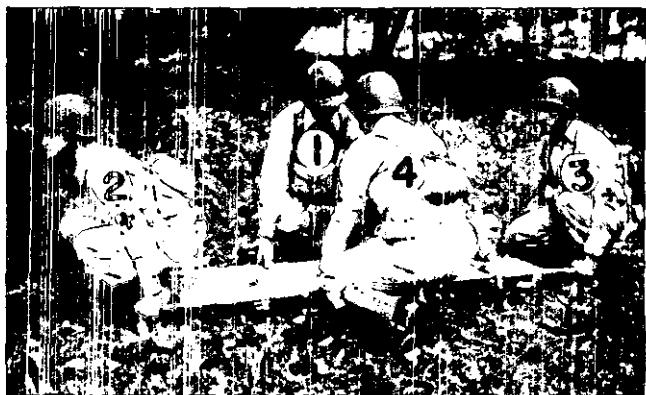

Figure 68. Squad at PREPARE TO LIFT, with straps.

adjust the litter-carrying straps of Nos. 2 and 3 respectively, and resume their posts (fig. 69).

46. TO MARCH FORWARD. The litter being at the lift, to march forward, the commands are: 1. **FORWARD**, 2. **MARCH**. At the command **MARCH**, No 2 steps off

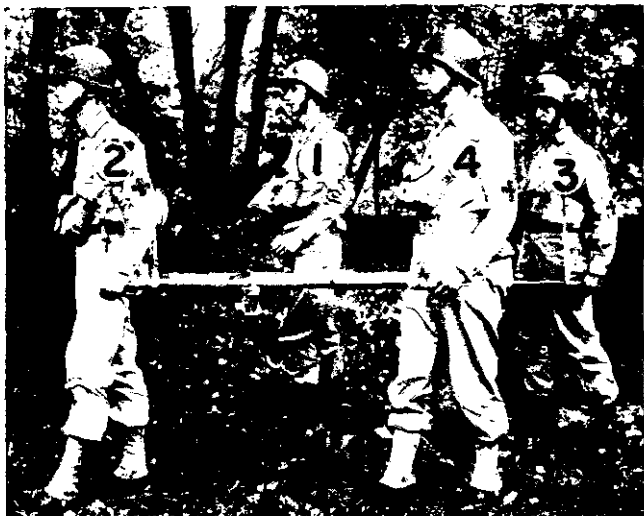

Figure 69. Litter lifted, with straps.

with the left foot, No. 3 with the right, both taking short, sliding steps of about 20 inches to avoid jolting and to secure uniform motion of the litter. Nos. 1 and 4 step off with the left foot employing the normal pace at a cadence to conform with the progress of Nos. 2 and 3.

47. TO LOWER LITTER. Being at the lift, to lower litter, the commands are: 1. **LOWER**, 2. **LITTER**. At the command **LITTER**, Nos. 2 and 3 slowly lower the litter to the ground, disengage the litter-carrying straps from the litter handles, and resume the erect position. Both ends of the open litter should be lifted and lowered slowly without jerking; the rear bearer moving in accord with the front bearer so as to keep the litter horizontal. The unloaded open litter should be handled for purposes of instruction, as a loaded litter. As soon as the men are familiar with the handling of the unloaded litter, instruction should be started using the loaded litter.

INSTRUCTION WITH LOADED LITTERS

48. **GENERAL.** a. **Patients for purposes of instruction.** For purposes of instruction with loaded litters, certain men are designated "patients." To make the instruction more realistic and to instruct in the handling of different types of injuries, patients may wear moulages, bandages, and splints to simulate actual disabilities. In early periods of instruction, these patients may be placed on the ground at suitable intervals near the line of litters, first with the heads and later with the feet toward the line. As the instruction progresses, the positions may be varied and lastly, the patients dispersed or concealed in such positions as they would occupy on the battlefield. When patients are loaded on litters, their equipment is carried by Nos. 1 and 4 or placed on the litter.

b. **Manner of instruction.** Several squads may be instructed simultaneously by one individual, or each squad may be instructed separately by an instructor or by the squad leader (No. 1). In the latter case, squad leaders assume charge when directed to do so by the instructor. At the signal for assembly, the squads form in line, lower litters, and come to rest. The patients, if still on the litters, are divested of dressings and splints, and resume their posts. "Patients" should be changed frequently so that they will get a chance to carry the litter.

c. **General rules for moving patients.** In moving the patient, either with or without the litter, every movement should be made deliberately and as gently as possible, care being taken not to jar the injured part. The command **STEADY** will be used to prevent undue haste and other irregularities.

(1) The rear bearer should watch the movement of the front bearer and time his own with them, so as to insure ease and steadiness of action.

(2) As a rule, the patient should be carried on the litter feet foremost, but in going uphill or upstairs his head should be in front.

(3) In case of fracture of the lower extremities, the patient is carried uphill or upstairs feet foremost and downhill head foremost. This prevents the weight of the body pressing upon the injured part.

(4) The litter must be kept as nearly level as possible at all times. Care must be taken to do this in passing obstacles and ditches.

49. TO LOAD AND UNLOAD LITTER. a. **Position for lifting patient.** The patient having been located, the general nature of his wounds having been determined, emergency treatment having been given, and a litter being open and available, to place bearers in proper position to lift patient, the commands are: 1. **RIGHT**



Figure 70. Squad at RIGHT SIDE, POSTS.

(LEFT) SIDE, 2. POSTS. At the command POSTS, bearers take position as follows: No. 2 at the right (left) ankle; No. 3 at the right (left) shoulder; Nos. 1 and 4 at the right and left hips, respectively, all facing the patient (fig. 70).

b. To lift patient and place litter in position. The bearers being at posts, to lift patient preparatory to placing him on the litter, the commands are: 1. LIFT, 2. PATIENT. At the preparatory command LIFT, all bearers kneel on knees nearest the patient's feet; No. 2 passes both forearms under the patient's legs, carefully supporting the fracture, if there is one; Nos. 1 and 4 place their arms under the small of the back and the thighs, not locking hands; No. 3 passes one hand under the patient's neck to the farther armpit, with the other supporting the nearest shoulder (fig. 71). At the command PATIENT, all lift together, slowly and carefully, and place the



Figure 71. Squad at LIFT.



Figure 72. First step after command PATIENT



Figure 73. Litter being placed beneath patient.

patient upon the knees of the three bearers on the same side (fig. 72). As soon as he is firmly supported there, the bearer on the opposite side (No. 1 or 4) relinquishes his hold, passes quickly by the nearest route to the litter which he takes up by the middle, one pole in each hand, and, returning rapidly, places it under the patient and against the ankles of the other three bearers (fig. 73).

c. **To lower patient on litter.** The patient being on the knees of three bearers, and the litter being in proper position to receive the patient, to lower patient on litter the commands are: 1. LOWER, 2. PATIENT. At the command LOWER, the free bearer (No. 1 or 4) resumes his former kneeling position opposite the other three bearers and prepares to assist in lowering the patient. At the command PATIENT, the patient is lowered gently upon the litter, made as comfortable as possible, then without further orders all bearers rise and resume their positions at litter posts.

d. **To unload litter.** The patient being on the litter, to unload litter, the same commands are given and the actions of the bearers are the same, with the following exception; after the patient has been lifted to the knees of the three bearers, the free bearer removes the litter from beneath the patient instead of placing it under him.

50. TO LOAD AND UNLOAD LITTER WITH THREE BEARERS. In the absence of one man from the litter squad, No. 3 or 2 is replaced by No. 4 or 1, respectively, With three bearers, the litter is placed as usual and, at the prescribed commands, the bearers take their proper positions. The patient, having been lifted by the three bearers, is supported on the knees of the two on one side, while the third (No. 1 or 4) places the litter in position (fig. 74). In like manner, the patient is lowered on the litter (fig. 75). To unload the litter, the procedure is reversed.



Figure 74. Loading litter with three bearers.



Figure 75. Lowering patient on litter (three bearers).

51. TO LOAD LITTER WITH TWO BEARERS.

a. With bearers on the same side. At the command **RIGHT (LEFT) SIDE, POSTS**, Nos. 2 and 3 take positions at patient's right (left) thigh and shoulder, respectively. (fig. 76.) At the command **LIFT**, bearers kneel on knees nearest the patient's feet; No. 2 passes his arms beneath the patient's hips and knees; No. 3 passes his arms beneath the patient's shoulders and small of his back. (fig. 77.) At the command **PATIENT**, they lift together, raising the patient upon their knees, then, readjusting their holds, rise to their feet and carry patient to the side of the litter. At the command **LOWER, PATIENT**, the bearers kneel and place the patient on their knees (fig. 78), stoop forward and place him on the litter (fig. 79),



Figure 76. Two bearers at RIGHT SIDE, POSTS.



Figure 77. Actions of two bearers at LIFT.



Figure 78. Two bearers after command LOWER PATIENT.



Figure 79. Two bearers placing patient on litter.

then rise and assume the position of LITTER POSTS without command. To unload, posts are taken in the same way, at the same commands.

b. With bearers on opposite sides. In case the patient is conscious and able to cooperate in the movement, a method whereby the bearers take positions on opposite sides of the patient may be employed. To carry out this movement, the commands are: 1. BOTH SIDES, 2. POSTS. At the command POSTS, Nos. 2 and 3 take positions at the patient's right and left hips, respectively, facing the patient (fig. 80). At the command LIFT, bearers kneel on the knees nearest the patient's feet, raise him to a sitting position, and pass their arms around his back and under his thighs, locking hands. The patient, if able,



Figure 80. Two bearers at BOTH SIDES, POSTS.



Figure 81. Two bearers ready to lift patient.

clasps his arms around the bearers' necks (fig. 81). At the command **PATIENT**, they lift the patient, both rising together, and carry him to the center of the litter (fig. 82). At the command **LOWER, PATIENT**, they stoop and lower the patient upon the litter in a sitting position, and the patient releases his hold on the bearers' necks (fig. 83). No. 3 then passes his left hand across the front of the patient's chest to the opposite armpit and grasps the patient. No. 2 releases his hold at the right side of the patient, steps astride the patient's legs, and grasps the patient's right and left thighs just above the knees with his left and right hands, respectively. Both bearers then turn and lower the patient upon the litter, head toward No. 3, when both bearers take the position of **LITTER POSTS** without command. Unloading is performed, in reverse order, at the same commands.



Figure 82. Two bearers ready to lower patient.



Figure 83. Bearers depositing patient on litter.

52. TO LOAD AND UNLOAD PATIENTS WITH BACK INJURIES. To avoid aggravating the condition of patients with actual or suspected back injuries, the following procedure will be followed:

a. The No. 4 man places a blanket, coat, or jacket, arranged in a firm roll or fold about two feet long and six inches in diameter, on the litter in a position to support the arch of the patient's back. To lift the patient on the litter, the No. 1 man places his hands under the patient's shoulders and controls his head, the No. 2 man places his hands under the small of the back and buttocks; and the No. 3 man places his hands under the thighs and calves. All men lean on their knee nearest the patient's feet. At the command **LIFT PATIENT**, Nos. 1, 2, and 3 gently lift the patient off the ground about 8 inches. In the meantime the No. 4 man procures the litter and places it under the patient. He also adjusts the roll on the litter under the patient's back. Then



Figure 84. Lifting patient with broken back.

at the command **LOWER PATIENT** the three bearers lean forward and lower the patient to the litter, with the aid of the No. 4 man (figs. 84 and 85).

b. In certain cases it may be necessary to tie the hands of the patient in front of him before placing him on the litter.

53. TO CARRY LOADED LITTER BY FOUR BEARERS. If it is desired that the four bearers carry the loaded litter, while marching, the commands are: 1. **BY FOUR**, 2. **CARRY**, 3. **LITTER**. At the command **LITTER**, No. 1 steps backward to the right rear, No. 4 forward to the left front, and each grasps the handle nearest him, relinquished by Nos. 2 and 3, respectively, who, retaining their grasp on the other handles, move to one side (fig. 86). Normal positions are resumed by the command **LITTER, POSTS**.



Figure 85. Placing patient with broken back on litter.

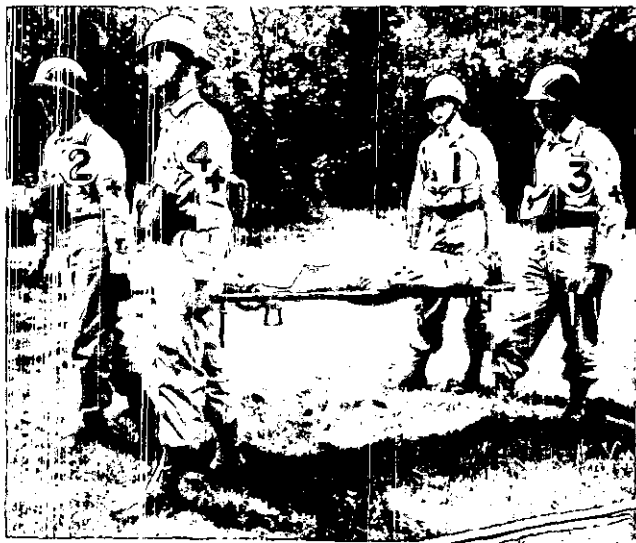
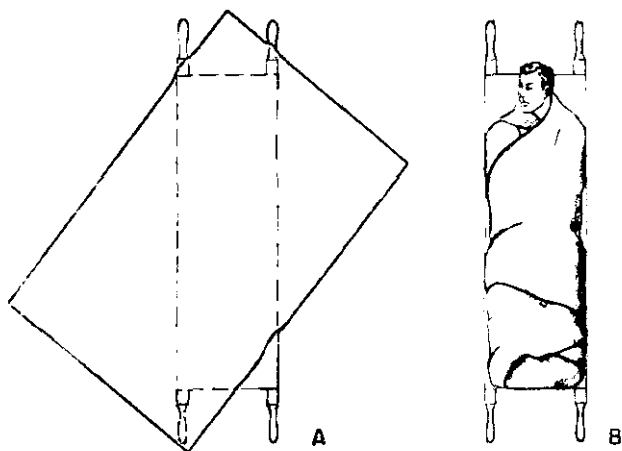

Figure 86. Loaded litter carried by four bearers.

Section IV. DRESSING THE LITTER

54. **GENERAL.** In cold weather it will be desirable to dress the litter prior to moving the patient in order to afford him warmth and comfort during transport and to reduce the danger of shock. One, two, or three blankets may be used to dress the litter.

55. **DRESSING LITTER WITH ONE BLANKET.** To dress the litter with one blanket, place the blanket diagonally over the litter (A, fig. 87). Place patient on the blanket, wrap the sides about his body, and tuck in at the head and feet (B, fig. 87).



A. Position of blanket.

B. Complete.

Figure 87. Dressing litter with one blanket.

56. **DRESSING LITTER WITH TWO BLANKETS.** To dress the litter using two blankets:

a. Place the first blanket lengthwise across the litter with the blanket edge close to or just beyond the head end of the litter (A, fig. 88).

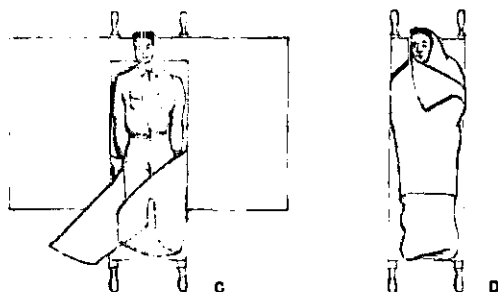
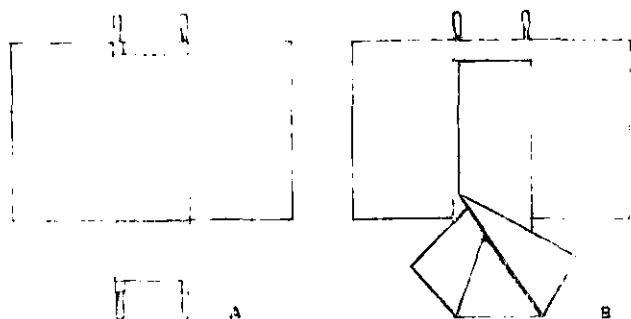

- A. Position of first blanket.*
B. Position of second blanket.
C. Patient on second blanket.
D. Complete.

Figure 88. Dressing litter with two blankets.

b. Fold the second blanket in thirds lengthwise and place over the first, the upper edge of this folded blanket being about ten inches below the upper edge of the unfolded one. The exact position of the second blanket depends upon the height of the patient, it being placed lower on the litter for taller men. Open the folds of the second blanket for about 2 feet at the foot end (B, fig. 88).

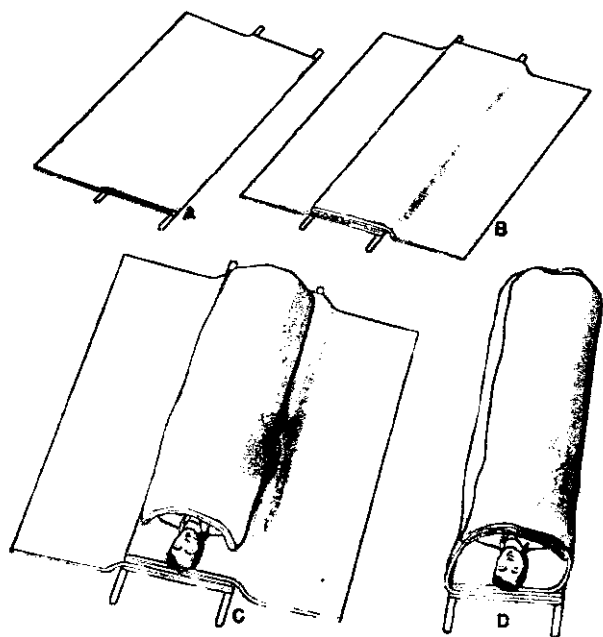

- A. First blanket.
- B. First two blankets.
- C. Third blanket.
- D. Complete.

Figure 89. Dressing litter with three blankets.

c. To wrap the patient, place him in position on the second blanket. Bring the bottom of the blanket up over the patient's feet, with a small fold between the feet. Tuck the two open folds closely over and around the feet and ankles (C, fig. 88). Finally, wrap first one and then the opposite side of the first blanket over the patient (D, fig. 88).

57. DRESSING LITTER WITH THREE BLANKETS.

To dress the litter using three blankets, proceed as follows:

a. Place the first blanket on the litter lengthwise so that one edge corresponds with the outer (or far) pole of the litter and the upper edge is even with the head of the canvas. Fold the blanket back upon itself once so that the folded edge is along the inside pole of the litter and the outer edge overhangs the outside pole (A, fig. 89).

b. Place the second blanket lengthwise on the first so that one edge corresponds with the inner pole of the litter and the upper edge is again even with the head end of the canvas. Then fold the blanket back upon itself so that the folded edge is along the outside pole of the litter and the other edge overhangs the inside pole (B, fig. 89).

c. After placing the patient on the litter, fold the third blanket once lengthwise and place it over the patient, one end under his chin. Then fold the free or overhanging edges of the first two blankets over the third and secure in place with safety pins or other available fastening device. (C, fig. 89). This method of dressing the litter gives four thicknesses of blankets over and four under the patient, thus assisting in the prevention of shock.

Section V. LITTER OBSTACLES

58. GENERAL. Obstacles include fences, hills, walls, ditches, running streams, or other natural or artificial impediments. Obstacles should be avoided when feasible, otherwise they must be surmounted. Orders for surmounting separate obstacles are neither necessary nor feasible. Hence, flexibility in the execution of orders concerning obstacles must be maintained, common sense dictating details of action most suited to the situation with which the bearers may be confronted.



Figure 90. Litter bearers handing loaded litter up 60° slope (Guadalcanal).

59. LITTER OBSTACLE COURSE. A litter obstacle course may be constructed to simulate most of the natural and artificial obstructions litter bearers are likely to meet. Such a course is not only useful in presenting obstacles of all kinds and teaching the proper methods of surmounting them, but also in conditioning bearers physically for the arduous tasks they will encounter in combat (fig. 90). Where construction of a litter obstacle course is impractical, many of the obstacles can be simulated from existing facilities.

60. TO PASS MINOR OBSTACLES. To cross wide, shallow streams, rough or cultivated ground, or similar obstacles, Nos. 1 and 4 close in, grasp the centers of the adjacent poles, and give support until the obstacle has been passed (fig. 91).



*Figure 91. Carrying litter over minor obstacles,
(rough terrain).*

61. TO PASS MAJOR OBSTACLES. a. To pass over fences, ditches, and similar obstacles, Nos. 1 and 4 close in and grasp the centers of the adjacent poles. No. 2 then relinquishes his grasp of the front handles and steps over the obstacle (fig. 92). The other three bearers then advance the litter until No. 2 can resume his grasp of the front handles. Nos. 2 and 3 support the litter by the front and rear handles respectively while Nos. 1 and 4 step across the obstacle. Having passed the obstacle, Nos. 1 and 4 again grasp the litter at the center. No. 3 then releases his hold of the rear handles and steps across the obstacle (fig. 93). Having crossed, he resumes grasp of the rear handles and Nos. 1 and 4 return to their posts.



Figure 92. Passing major obstacle (low hurdle); first step.



Figure 93. Passing major obstacle; second step.

b. When a major obstacle is of such length that the procedure described in "a" is impossible, Nos. 1 and 4 close in and grasp the sides of the litter. All four bearers then proceed, making their way over the obstacle and supporting the litter together (fig. 94).



Figure-94. Passing major obstacle, four bearers support litter.

c. When a long litter carry involving a series of major obstacles must be negotiated, six men should be employed if they are available. The four regular bearers being in the position of **BY FOUR, CARRY, LITTER**, the two additional bearers grasp adjacent litter poles at the center and all advance supporting the litter whenever an obstacle of sufficient difficulty is encountered (fig. 95).

62. TO SURMOUNT OBSTACLES OVER 5 FEET HIGH. The squad being in position of **BY FOUR, CARRY, LITTER**, to surmount an obstacle over 5 feet high, the litter is raised carefully to the level of the obstacle and



Figure 95. Carrying litter over major obstacle. Use of six bearers (Attu, Aleutian Islands).

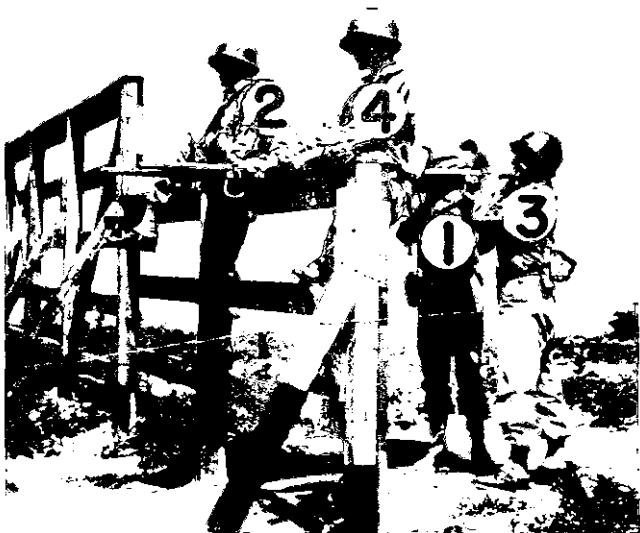

Figure 96. Surmounting obstacle over 5 feet high (high hurdle).

advanced until the front of the litter has cleared, or become well anchored on, the obstacle. Nos. 2 and 4 then clear the obstacle (fig. 96), assist in advancing the litter to the rear stirrup, then steady it while Nos. 1 and 3 clear the obstacle and resume their grasp on the rear handles. Upon clearing, the litter is lowered to its former level.

63. TO CARRY LOADED LITTER UPSTAIRS AND DOWNSTAIRS. a. **Upstairs carry.** Normally, a loaded litter is carried upstairs head first (par. 48c). The litter is carried to the foot of the stairs in the usual manner, wheeled about, and halted (fig. 97). To negotiate the stairs, Nos. 1 and 4 grasp the litter at the centers of the poles. Nos. 2 and 3 then relinquish their grasps, face about (fig. 98), and resume hold of the handles. No. 4 then steps to the handle nearest him at the foot of the litter and secures a grasp upon it while No. 2 grasps the opposite rear handle. No. 1 meanwhile lets go of the litter and advances part way up the stairs (fig. 99); Nos. 2, 3, and 4 now carry the litter up the stairs, the rear bearers being responsible for maintaining the level position of the litter while No. 1 renders whatever assistance he can (fig. 100). When only three bearers are present, the litter must be placed on the ground while the bearers change position at the foot of the stairs. After surmounting the stairs, normal positions are resumed.

b. **Downstairs carry.** Normally a loaded litter is carried downstairs feet first (par. 48c); thus, when upstairs and downstairs obstacles are combined, the litter must be wheeled about at the top of the obstacle prior to descent (fig. 101). To proceed down the stairs, No. 4 grasps the left front handle and No. 2 the right front. No. 3 maintains hold of the rear handles and, assisted by No. 1, is responsible that the litter be maintained level during the descent (fig. 102). Having reached the foot of the stairs, bearers resume the position of LITTER, POSTS (fig. 103).



Figure 97. Upstairs carry; first step. Litter wheeled around so that head is toward stairs.

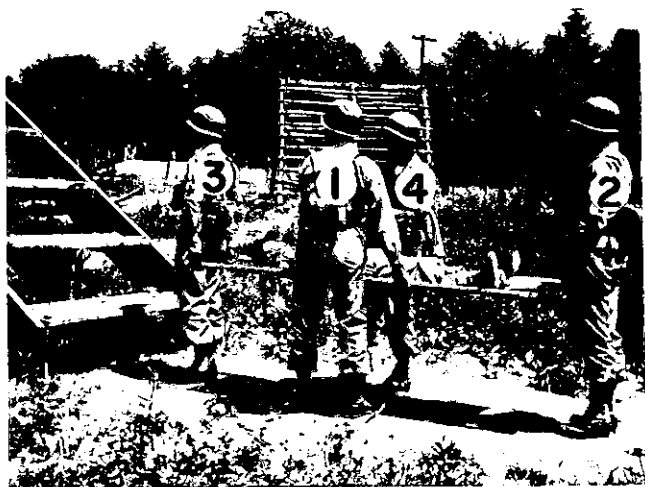

Figure 98. Upstairs carry; second step. Litter bearers face toward stairs.

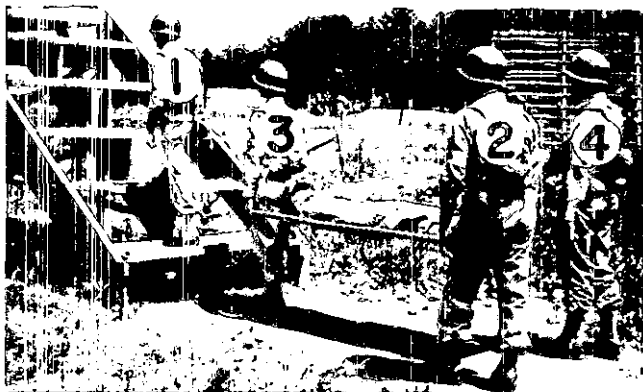

Figure 99. Upstairs carry; third step. No. 1 lets go and advances part way upstairs. No. 4 aids No. 2 at rear of litter.

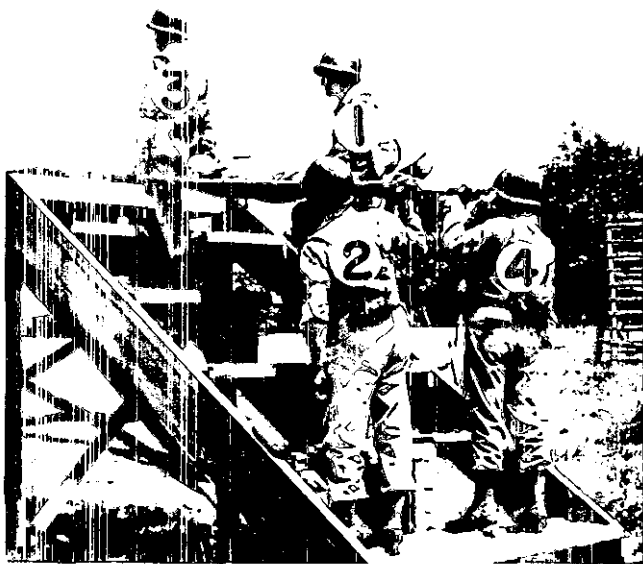

Figure 100. Upstairs carry; fourth step. Nos. 3, 4 and 2 carry the litter while No. 1 assists.

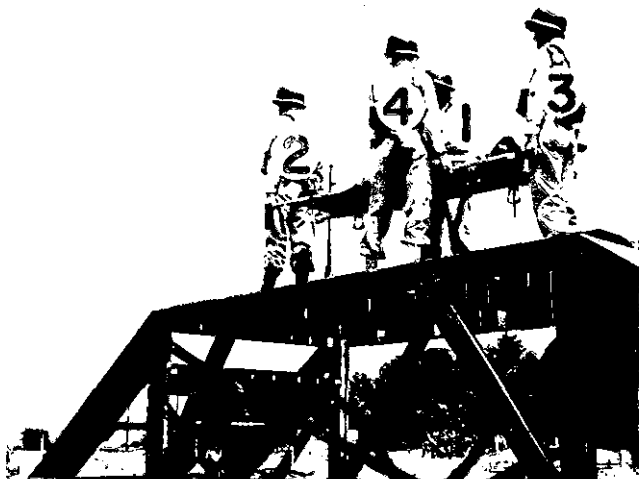

Figure 101. Downstairs carry; wheeling litter into feet first position for descent.



Figure 102. Downstairs carry; No. 1 assists.



Figure 103. Downstairs carry completed. Bearers at LITTER, POSTS.

c. Carrying patients with leg fractures. When the patient being transported has a fracture of the leg, or if for any reason it is considered desirable to carry the patient upstairs feet first or downstairs head first, the bearers are reversed, in the former case No. 2 becoming the front bearer and in the latter, No. 3.

64. TRENCHES, DUGOUTS, AND OTHER EXCAVATIONS. To negotiate narrow trenches, dugouts, and the like, Nos. 2 and 3 maintain their positions at the handles, lifting the litter over their heads and above the narrow trench. Nos. 1 and 4, having stepped beneath the litter, grasp the litter poles and assist in supporting the litter as all advance (fig. 104).



Figure 104. Carrying litter through narrow trench.

65. CULVERTS, TUNNELS, AND LARGE PIPES. To negotiate culverts, tunnels, large pipes, and similar obstacles, No. 2 faces the litter and backs through the obstacle, No. 3 maintaining hold of the rear handles. No. 1 precedes and No. 4 follows the litter (fig. 105).

66. NARROW BRIDGES, GANGPLANKS, CATWALKS, NARROW PATHS, ETC. In carrying litter across any obstacle too narrow to permit bearers advancing in normal positions, No. 1 precedes and No. 4 follows the litter as Nos. 2 and 3 maintain their usual positions of carry (fig. 106).

67. CRAWL CARRY. To negotiate areas exposed to hostile fire, shallow depressions where cover is desired, and similar obstacles, the four bearers secure litter-carrying straps to their suspenders, kit, medical private (ch. 3), and kneel beside the four litter stirrups. Each



Figure 105. Carrying litter through culvert.



Figure 106. Carrying litter across narrow bridge.

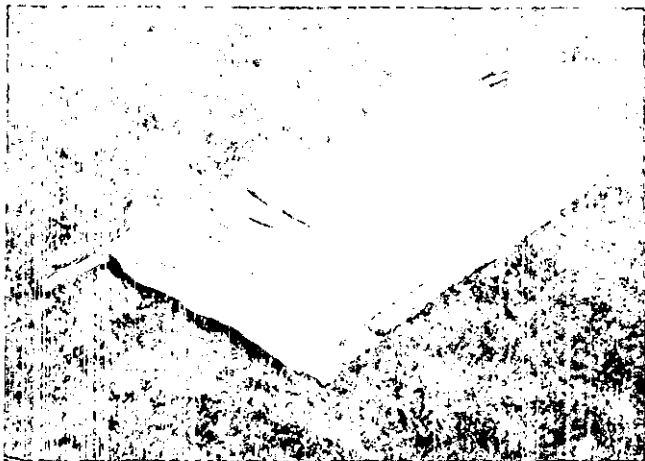

Figure 107. Crawl carry.

bearer loops the strap nearest the litter around the litter stirrup adjacent to him. Then all advance by crawling on hands and knees, dragging the litter as they move (fig. 107).

Section VI. IMPROVISED LITTERS

68. GENERAL. Sometimes you will have to move a casualty when there is no Medical Department litter available. Short distances may be covered by means of manual carries described in chapter 1 if the patient's injury will not be made worse by such a procedure. If the distance is long or the patient has such an injury as a broken leg, back or neck, a litter should be improvised with materials at hand. Several types of improvised litters are described in the following paragraphs.



*Figure 108. Improvising litter with poles and blanket;
position of first pole.*

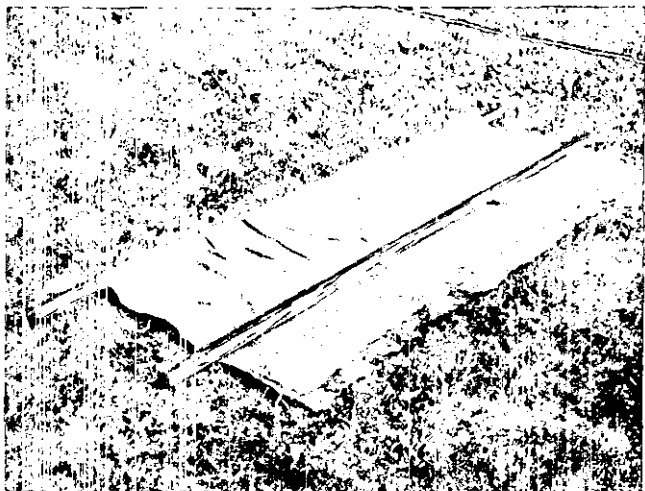

*Figure 109. Improvising litter with poles and blanket;
position of second pole.*



Figure 110. Improvising litter with poles and blanket; litter completed.

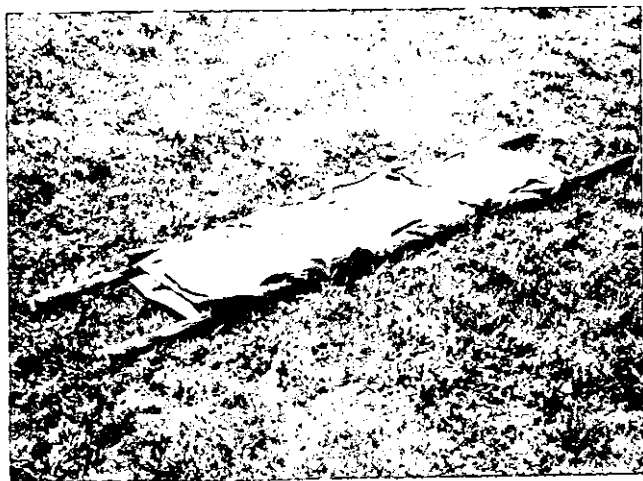

Figure 111. Litter improvised from poles and field jackets.



Figure 112. Door used as a litter.

69. POLE AND BLANKET LITTER. A blanket, shelter half, tarpaulin, or similar material may be used for the litter bed. Improvise the poles from branches, boards, tent poles, skis, lengths of pipe, rifles, or any appropriate objects at hand.

- a. Spread the blanket open on the ground.
- b. Lay one pole lengthwise across the center, and fold the blanket over (fig. 108).
- c. Place the second pole across the center of the new fold (fig. 109).
- d. Fold free edges of the blanket over the second pole (fig. 110).

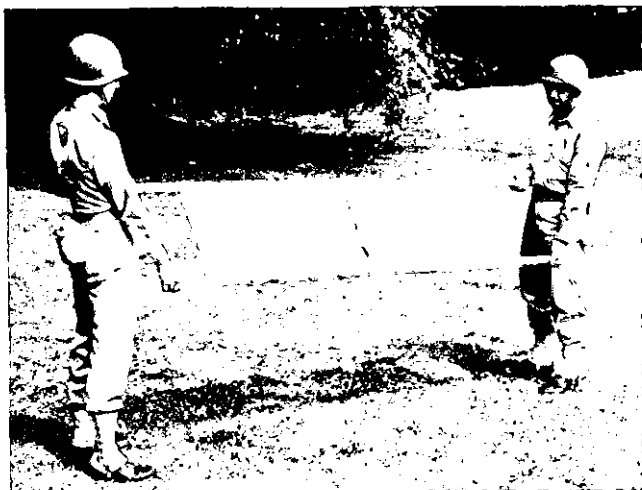

Figure 113. Litter improvised from poles and sacks.

70. POLE AND JACKET LITTER. You can make a litter by folding two or three blouses, shirts, or field jackets so that the lining is outside, buttoning them up sleeves in, and passing a pole through each sleeve (fig. 111).

71. DOOR OR BOARD LITTER. You may use any plane-surfaced objects of suitable size, such as cots, window shutters, doors, benches, ladders, boards, or poles tied together (fig. 112). Pad the litter if possible.

72. POLE AND SACK LITTER. Rip open the bottoms or cut the corners of sacks, bags, bedticks, or mattress covers, and pass two poles through them (fig. 113).

73. BLANKET LITTER. If no poles can be obtained, roll a blanket, shelter half, tarpaulin, or similar object, from both sides toward the center (fig. 114). Use the rolls as grips when carrying patient.



Figure 114. Rolled blanket used as a litter.

CHAPTER 3

AIDS IN LITTER TRANSPORTATION

Section I. TYPES OF AIDS

74. **GENERAL.** The manual carrying of a loaded litter is one of the most grueling tasks performed by the personnel of the Medical Department. In prolonged actions, the critical point in the chain of evacuation within the division lies between the casualty on the field and the most forward ambulance. Therefore, every effort is made to minimize the task of litter bearers. Front line medical installations, including advanced ambulance loading posts, are placed as far forward as the situation and terrain will permit, and any mechanical device which will aid the litter bearers and accelerate the tempo of evacuation is employed whenever feasible.

75. **LITTER-CARRYING STRAPS.** Each Medical Department soldier carries in his left hand medical pouch two litter-carrying straps. These straps consist of adjustable lengths of 1-inch webbing with hooks at each end (fig. 115). They may be hooked on the front and rear

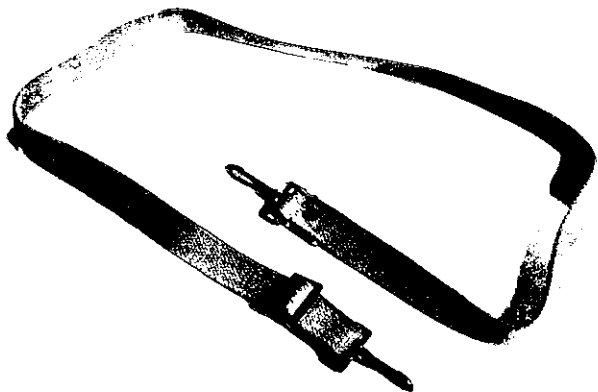

Figure 115. Litter-carrying straps.



Figure 116. Litter-carrying straps in use.

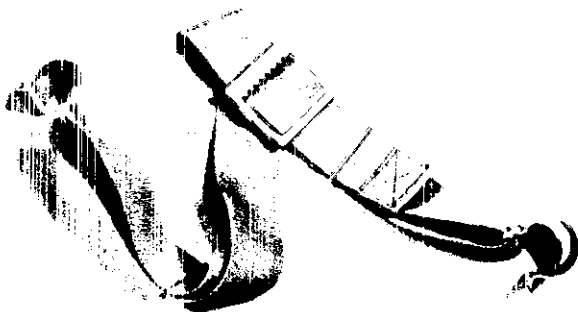

Figure 117. Litter securing strap.

of the suspenders, medical kit, private, and the handles of the litters supported in the loops thus formed (fig. 116). Two men can carry a litter with much less fatigue by using these straps.

76. LITTER SECURING STRAP. Litter securing straps are available in the ratio of four per litter. The strap consists of a length of 2-inch webbing with buckle and two metal hooks, one at each end (fig. 117). The purpose of the securing strap is to hold litter patients in position on the litter, thus facilitating movement and obviating danger of the patient falling from the litter. The litter securing strap is so designed as to fit all standard Army litters. The straps are used in numbers according to circumstances. When movement is over relatively level areas, two securing straps will generally be sufficient; one across the patient's chest and one across his legs below the knees (fig. 119). In securing the straps,

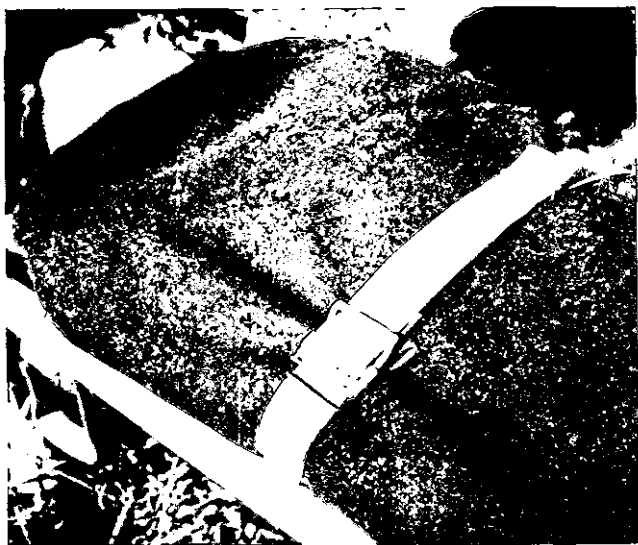

Figure 118. Method of fixing strap in place.

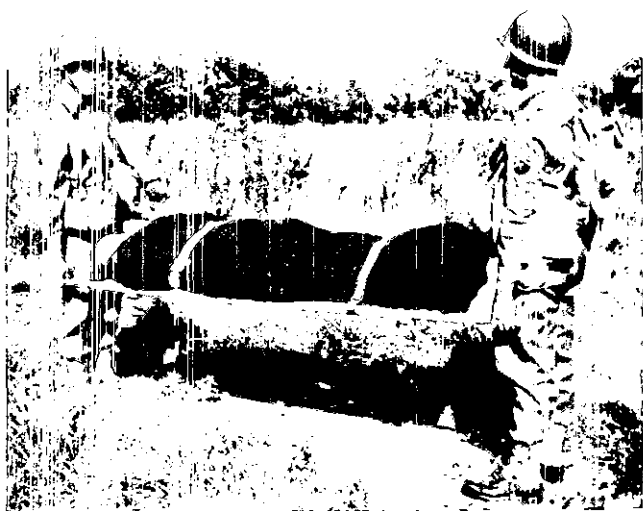

Figure 119. Two securing straps (for normal terrain).



Figure 120. Four securing straps (for rough terrain).

one end is fastened by the metal hook to the litter pole; the strap is then carried across the patient's body and fixed to the far litter pole by the hook on the other end of the strap (fig. 118). When the litter is to be moved over rough terrain or the proposed movement is of such a nature that there is particular danger of a patient slipping from the litter, all four securing straps are used. The four straps may be applied one across the chest, one across the waist, one across the thighs, and one across the legs below the knees (fig. 120). However,



Figure 121. Four securing straps fixed for vertical movement.

when considerable movement of the litter in a vertical direction is contemplated, the following method of application is employed. Two straps are applied across the chest and legs as before and the other two as follows: one is clasped to the litter pole, carried over the thigh of one leg, passed between the legs and under the other leg to the far pole. The other strap is applied in the reverse manner; that is, clasped to the far pole, carried over the thigh of the far leg, under the near leg, and finally attached to the near pole (fig. 121). Whenever litter securing straps are used, care must be taken that the strap is so placed as not to interfere with whatever wounds may be present. If the patient suffers a broken leg which has been splinted, straps are passed over only the uninjured leg, since the litter bar will serve to hold the splinted leg in position.

77. WHEELED LITTER CARRIER. a. **Description.** The standard wheeled litter carrier is a collapsible, 2-wheeled cart, capable of transporting one loaded litter. Its weight is 59 pounds and its measurements are as follows: open, width 32½ inches; over-all height 31 inches; length 28 inches; folded, 9 by 28 by 61½ inches. Folded, it occupies approximately 10 cubic feet of space. Wheels are bicycle type with wire spokes, equipped with pneumatic tires size 26 by 2. It is equipped with two full elliptical springs upon which the litter is supported by a pair of angle brackets, held in position by a pair of screw brackets. The carrier, open, is kept in upright position by a hinged, tubular, metal, inverted V-shaped support stand which, when not in use, folds centrally from its lateral attachment to the axle rod, to be held in place by a spring latch.

b. **Advantages of standard wheeled litter carrier.** (1) *Collapsibility.* The shape plus the space requirements, assumed by the carrier when collapsed, facilitates its transportation to and from the place of actual employment, either as part of a top load or attached to the rear of an ambulance or truck by means of appropriate hooks.



Figure 122. A wheeled litter carrier being used near Anzio, Italy.

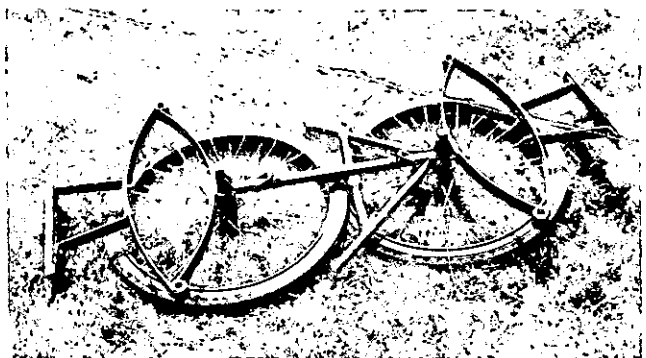

Figure 123. Carrier, wheeled litter, collapsed.

(2) *Economy of personnel.* Over suitable terrain, the litter squad employing the carrier may be reduced to two men, and the smaller squad still performs the same task with increased rapidity and less fatigue.

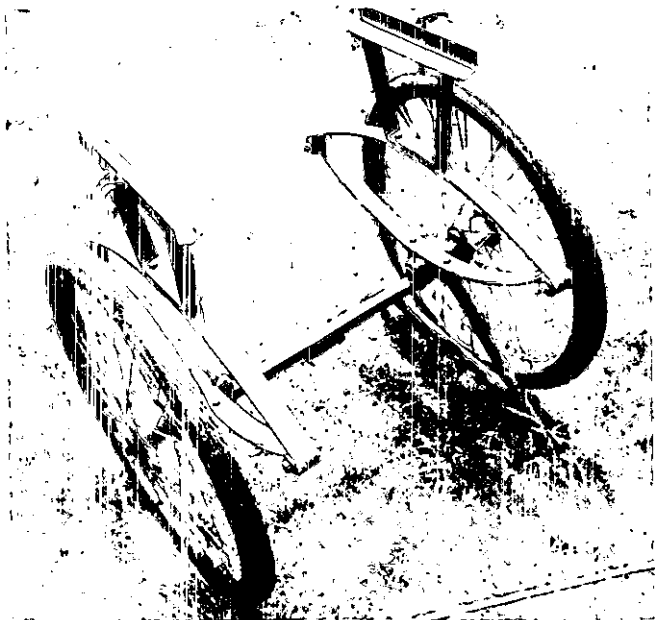

Figure 124. Carrier, wheeled litter, open.

(3) *Employment in mud and sand.* Because of the wide pneumatic tire, employment of the carrier in mud and sand becomes reasonably feasible.

(4) *Increased comfort for passenger.* The pneumatic tires and elliptical springs increase the comfort of the patient being transported and, at the same time, decrease the tendency of the movement to cause or aggravate the condition of shock.

(5) *Safety factors.* (a) *Balance.* The vehicle is well balanced and the center of gravity is so located as to minimize the likelihood of overturning.

(b) *Litter lock.* The loaded litter is securely locked to the carrier during movement, thus making it impossible for the litter to be accidentally unloaded. This also

enables bearers to lift litter and carrier over minor obstacles without dismounting the litter.

(c) *Support stand.* Safety during loading and unloading is insured by the stabilizing effect of the support stand.

78. USES OF THE CACOLET AND TRAVOIS. a. *Cacolet.* A Cacolet is a pack saddle fitted with a litter. Many types have been used. A Cacolet can be improvised using standard army pack saddles and litters. It is particularly useful in mountain or jungle country where long litter carries would otherwise be necessary. (See fig. 125).

b. *Travois.* The travois is a contrivance for transportation of sick and wounded, consisting of two long poles lashed at one end to each side of a horse or similar animal, the other ends trailing the ground. Hurdles are lashed across these poles to receive the load. A travois may be constructed by cutting poles about 16 feet long and 2 inches in diameter at the small end. These poles are laid parallel to each other, large ends to the front



Figure 125. Cacolet.



Figure 126①. One-horse travois.

and $2\frac{1}{2}$ feet apart, the small ends 3 feet apart with one of the latter projecting some 8 or 10 inches beyond the other to impart a rocking rather than a jolting motion to the load. The poles are connected by a crossbar about 6 feet from the front ends and another about 6 feet back of the first, each notched at the ends and securely lashed to appropriate notches in the long poles. Between



Figure 126②. Two-horse travois.

the crosspieces, the litter bed, 6 feet long is filled in with canvas, blanket, or similar material, securely fastened to the poles and crossbars. In lieu of canvas or a blanket, rope, or straps may be stretched obliquely from pole to pole, in many turns, crossing each other to form the basis for a light mattress or improvised bed. A litter or cot may be fastened between the poles for the same purpose. The front ends of the poles are securely fastened

to the saddle of the animal, and joined around the animal's chest by means of a breast strap. On the march, bearers should be ready to lift the rear end of the travois when passing obstacles, streams, or when going up-hill. If desired, the rear ends of the poles, instead of being allowed to drag, may be lashed to the saddle of a second horse, following the first in tandem. (See fig. 126②).

79. AIDS IN SNOW TRANSPORTATION OF WOUNDED. The transportation of wounded over snow covered terrain is difficult without special snow equipment. Following are a number of standard items that make evacuation over snow easier for the litter bearers and more comfortable for the patient.

a. **Litter ski adapter.** Four of these small clamps will attach a standard litter to any pair of standard skis. The casualty can then be loaded on the litter and pulled along by ropes or a harness.

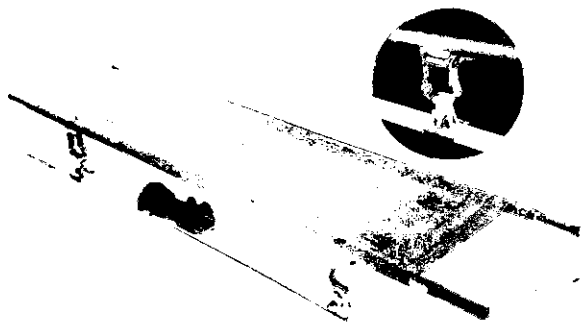

Figure 127①. A standard litter attached to skis by "Litter Ski Adapters."

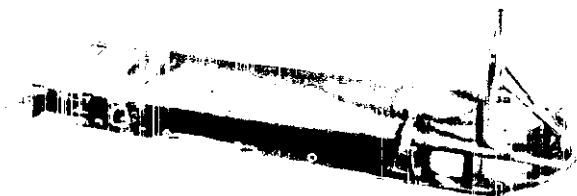

Figure 127②. Litter mounted on a military toboggan by means of toboggan litter adapters.

b. **Toboggan litter adapter.** A military toboggan may be fitted with a litter by means of toboggan litter adapters. The standard toboggan harness can be used to pull the toboggan.

c. **Casualty evacuation sleeping bag.** In order to keep a casualty warm in cold climates, an adaptation of the sleeping bag is issued. It is called the casualty evacuation sleeping bag, and zips up to protect all parts of the patient. It is used instead of blankets and is adapted for use with standard litters, toboggans, etc.



Figure 127③. A casualty evacuation sleeping bag used with a toboggan.

Section II. INSTRUCTION IN THE USE OF THE WHEELED LITTER CARRIER

80. GENERAL. a. **Purpose.** The purpose of this section is to furnish a guide for instruction in the use of the wheeled litter carrier and thereby standardize and accelerate such training.

b. **Scope.** It includes instruction in opening, closing, loading and unloading of the carrier.

c. **Objectives.** The objectives of this instruction will be a thorough knowledge of the mechanism, and a high degree of proficiency in the employment of the carrier.

d. **Commands.** Any commands used are for the purpose of instruction and their employment in the field is not contemplated.

e. **Formation for instruction.** For purposes of instruction in the use of the wheeled litter carrier, groups of three are preferable, men within the group alternating in the role of patient. The two members of the group acting as bearers are designated Nos. 1 and 2, No. 1 being in charge.

81. TO OPEN AND CLOSE CARRIER. a. **To open carrier.** The carrier being on the ground folded, to open, the commands are: 1. **OPEN**, 2. **CARRIER**. At the command **CARRIER**, the following steps of procedure are executed:

(1) Both bearers proceed by the most direct route to the folded carrier and take positions, one on each side adjacent the wheels, No. 1 on the side to which the support stand is attached (fig. 128).

(2) Bearers stoop, grasp the litter pole racks (fig. 129) and, in unison, lift them until the wheels are in upright position (fig. 130).



Figure 128. Bearers in position to open carrier.

(3) Maintaining the upright position of his respective wheel with his left hand, each bearer, with his right, pushes lock into position and secures it by tightening the setscrew (fig. 131).

(4) No. 1 unlatches the support stand and brings it down to the vertical (fig. 132).

(5) Both bearers loosen the screw brackets and swing them laterally, leaving the litter pole racks open to receive the litter, then they resume their positions at the wheels, facing the carrier (fig. 133).

b. To close carrier. The carrier being open and unloaded, to close carrier, the commands are: 1. CLOSE, 2. CARRIER. At the command CARRIER, bearers move



Figure 129. Opening carrier; first step. Bearers grasp litter pole racks.



Figure 130. Opening carrier; second step. Bearers lift wheels to upright position.



Figure 131. Opening carrier; third step. Bearers lock wheels into position.

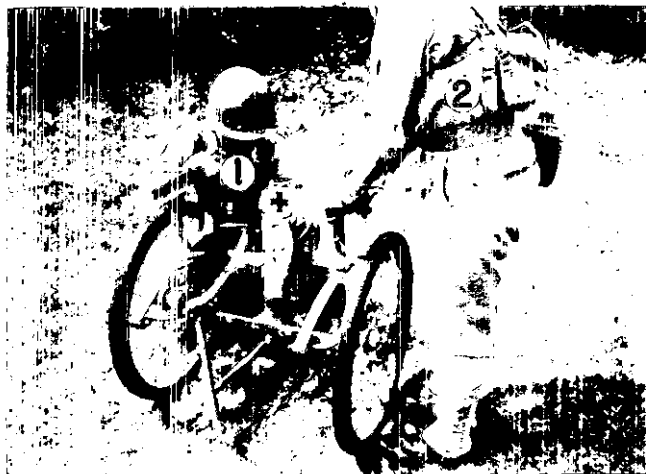

Figure 132. Opening carrier; fourth step. No. 1 lets down support stand.



Figure 133. Opening of the carrier completed.

directly to positions at wheels, if not already there, and proceed to perform in reverse order, the same steps as required to open it (a above). Screw clamps are moved centrally and tightened; No. 1 lifts the support stand and latches it; both unfasten wheel locks, and, in unison, allow wheels to fold at the axle joints. When the carrier has been completely closed, bearers resume upright position.

82. TO LOAD AND UNLOAD CARRIER. a. To load carrier. The carrier being open and conveniently located, to place bearers in position to proceed with the loading, the commands are: 1. FACING PATIENT, 2. LITTER, 3. POSTS. At the command POSTS, bearers move by the most direct route and take positions between the handles of the litter, Nos. 1 and 2 facing the patient's head and

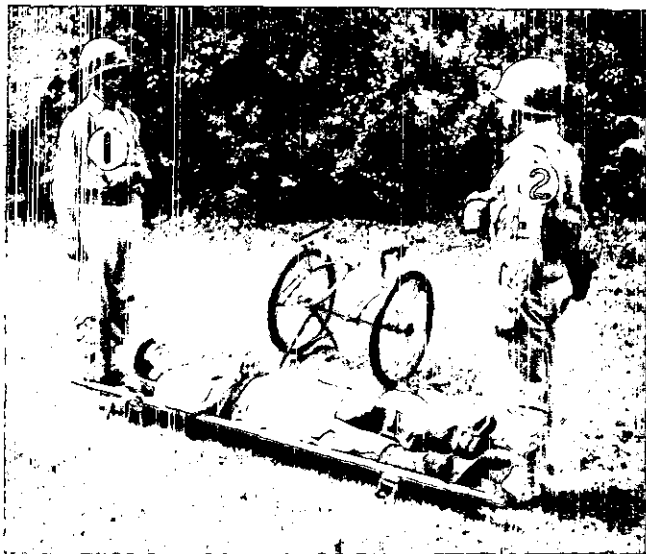

Figure 134. Bearers at FACING PATIENT, LITTER, POSTS.

feet, respectively (fig. 134). The litter being loaded, the bearers at posts, and the command PREPARE TO LIFT, LIFT having been given and executed, to load carrier the commands are: 1. LOAD, 2. CARRIER. At the command CARRIER, the procedure is as follows:

(1) Bearers carry the litter and place it on the carrier, the poles lying firmly in the racks and the litter well balanced on the carrier (fig. 135).

(2) No. 1 remains in position and steadies the litter while No. 2 locks poles into racks by adjusting and tightening the screw brackets (fig. 136).

(3) No. 2 folds and latches the support stand (fig. 137), and resumes his position at the patient's feet, facing front. Bearers are now ready to move out (fig. 138).



Figure 135. Placing loaded litter on carrier.



Figure 136. No. 2 locking poles to racks.

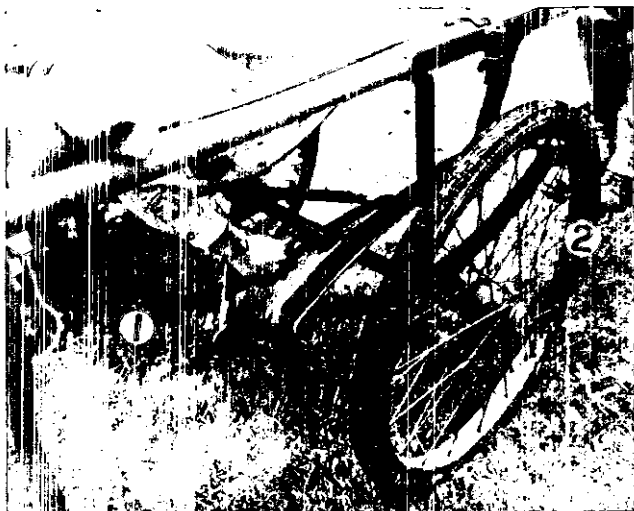

Figure 137. No. 2 latching support stand.

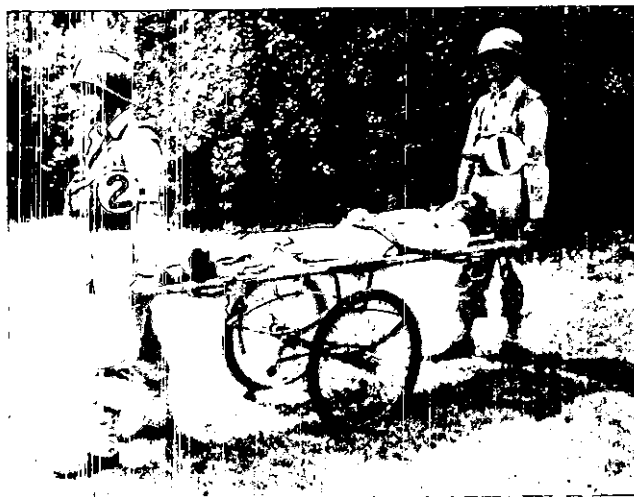

Figure 138. Carrier loaded, bearers ready to move out.

b. To unload carrier. The carrier being loaded and the bearers being in position for movement, to unload carrier, the commands are: 1. UNLOAD, 2. CARRIER. At the command CARRIER, No. 1 stands fast and steadies the litter while No. 2 loosens the screw brackets, moves them laterally, unlatches and lowers the support stand, and resumes his post, facing the patient's feet. Without further command, bearers lift litter, move it clear of the carrier, and perform further actions at the command of the instructor or No. 1 bearer.

CHAPTER 4

MOTOR AMBULANCE TRANSPORTATION

Section I. GENERAL

83. **DEFINITION.** A motor ambulance is a motor vehicle designed for the conveyance of the sick and wounded.

84. **REQUIREMENTS OF FIELD AMBULANCE.** Following is a list of the necessary or desired requirements of an ambulance designed for field use. Both the standard Truck, ambulance, $\frac{3}{4}$ -ton, 4×4 K.D. and the limited standard Ambulance, $\frac{3}{4}$ -ton, 4×4 , meet these requirements. For exact specifications of all ambulances, see TM 9-2800.

a. **Capacity.** The vehicle should be capable of transporting eight sitting or four litter cases, with equipment, a maximum load of approximately 1,500 pounds.

b. **Speed.** The ability to travel 50 miles per hour on suitable roads is desirable.

c. **Cruising radius.** Fuel capacity should be sufficient to carry the vehicle at least 200 miles.

d. **Ability to cross rough terrain.** A reasonable ability to overcome such obstacles as steep inclines, shallow ditches and streams, cultivated ground, loose boulders, muddy or swampy ground, sand, and snow is essential.

e. **Ease in driving.** Ease in driving is necessary to prevent undue driver fatigue in periods of sustained activity.

f. **Riding comfort.** The vehicle, to best serve not only the patient's comfort but also his general condition, should possess a satisfactory type spring, and facilities for heating, lighting, and ventilating the interior.

g. **Safety factors.** The safety of operating and passenger personnel should be considered in the selection of such equipment as brakes, lights, horns, shatter-proof glass, and similar items.

85. AMBULANCE PERSONNEL AND EQUIPMENT.

The ambulance crew consists of two men; one the driver, and the other the ambulance orderly. The driver is responsible for the vehicle at all times. He performs 1st echelon maintenance and is responsible for reporting major defects to his section leader or, if the latter is not available, to the unit transportation sergeant or mechanic. The ambulance orderly acts as assistant driver, prepares the ambulance for loading and unloading, prepares it for departure after loading and unloading, and renders necessary emergency treatment to patients being transferred. Ordinarily all field ambulances will carry four litters and a supply of blankets and splints.

86. TYPES OF AMBULANCES. a. **Field ambulances.**

Field ambulances must have the ability to cross rough ground, climb steep grades, negotiate mud holes, etc. They should have large tires, have a high clearance, and have four wheel drive and four speeds forward.

(1) *Truck, ambulance, ¾-ton, 4 × 4, knockdown.* This is the standard ambulance for Medical Department units. It is capable of being partially disassembled so that the body will fit into a space about 1½ feet high. It has berths for four litter cases. Two additional litter cases may be placed on the floor in emergency but it is considered a four litter ambulance in order that attendants can properly care for patients. It can carry eight sitting cases. The body of the ambulance is separate from the driver's seat and can be entered from the driver's seat by a small door. The body is gas proof and is ventilated, lighted and heated. Patients may be cared for by the ambulance orderly, who can walk in the aisle between the berths. Litters can be stored folded under the seats when not in use.



Figure 139. Truck, ambulance, 3/4-ton, 4x4, knockdown.



Figure 140. Truck, ambulance, 3/4-ton, 4x4, knockdown—rear view.

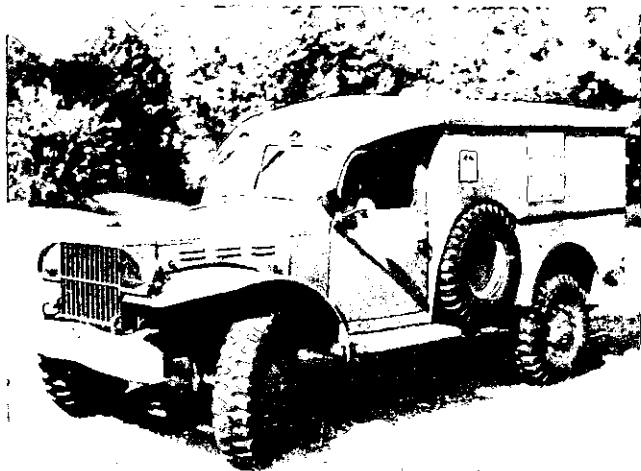

Figure 141. Ambulance, 1/4-ton, 4 × 4.

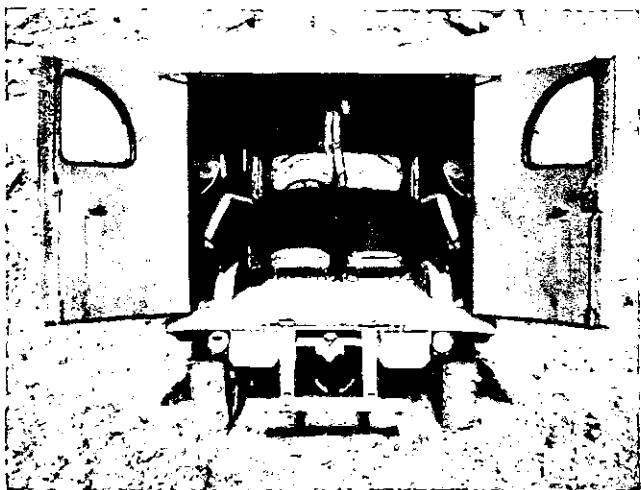

Figure 142. Ambulance, 1/4-ton, 4 × 4—rear view.

(2) *Ambulance, ¾-ton, 4×4.* This ambulance is commonly supplied when the standard Truck, ambulance, ¾-ton, 4×4, knockdown, is unavailable. It has berths for four litter patients and can carry eight sitting patients. Its main disadvantage is the lack of space for nursing litter patients en route.

b. *Metropolitan ambulance.* The large metropolitan ambulance is supplied to named general hospitals and some other large hospitals in the zone of the interior. It is designed for use on good roads only. The ambulance cot litter, Bomgardner type, is used with this ambulance. Its capacity is one or two patients.



Figure 143. Metropolitan ambulance.

Section II. INSTRUCTION IN AMBULANCE LOADING AND UNLOADING

87. GENERAL. a. Ambulance loading as done by formal commands is for instructional purposes only, to teach men to work smoothly as a team, each knowing exactly what his particular job is. In these instructions formal commands are given and the men are numbered so that you can see what each man does. Details of the actual loading and unloading will vary slightly, depending on the number of bearers, presence or absence of ambulance orderly, and type of ambulance employed. Demonstration of the steps in ambulance loading, followed by application is the recommended method of instruction.

b. General rules. (1) *Berths and order of loading.* The four longitudinal spaces formed within an ambulance, when loaded litters are in place, are known as berths and are designated right (left) upper (lower). When loading two litter and one or more sitting cases, the right berths are used for the loaded litters, the order being right upper, and right lower. When loading two litter and no sitting cases, the lower berths are used, the order being right lower, and left lower.

(2) *Patients with splints.* Patients with cumbersome splints will be loaded in lower berths, when the situation permits.

(3) *Position of patient in ambulance.* Unless otherwise indicated, litter cases will be loaded head first. Prior to loading, litters will be grounded three paces to the rear of, and with the patient's head toward, the ambulance.

88. TRUCK, AMBULANCE, $\frac{3}{4}$ -TON, 4x4, KNOCK-DOWN. A squad of three men is needed to load or unload this ambulance. Four loaded litters should be available in the immediate vicinity of each ambulance. The squad being in the vicinity of the ambulance, to assemble prior to loading or unloading the commands are: 1. AMBULANCE, 2. POSTS. At the command POSTS the members of the squad move rapidly by the shortest practicable route to the ambulance and align themselves in numerical sequence from left to right, one pace in the rear of and facing the ambulance.

a. To load ambulance. The squad being at AMBULANCE POSTS the command 1. PREPARE AMBULANCE FOR, 2. LOADING is given. At this command No. 1 performs the following duties (figs. 144, 145, 146, 147, and 148):



Figure 144. Opening doors.



Figure 145. Lowering rear step (seat).



Figure 146. Raising backs of seats to form upper berths.



Figure 147. Squeezing rods together to lower upper berths.

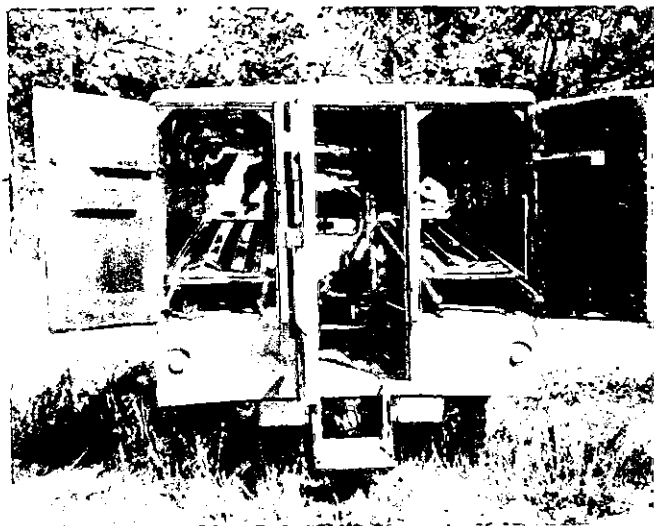

Figure 148. Ambulance ready for loading.

- (1) Opens all three rear doors,
- (2) Lowers the rear step,
- (3) Raises the backs of the seats to form the upper berths,
- (4) Pulls out rods, squeezes them together and lowers the rear end of both upper berths.

The ambulance is now ready for loading and No. 1 re-assumes his place at **AMBULANCE POSTS** (Fig. 149). To proceed with loading the command is:

1. **RIGHT UPPER BERTH PREPARE TO LOAD**, 2. **LOAD**. At the first command bearers take positions as follows: No. 2 at foot of litter facing patient, stoops and grasps handles; Nos. 1 and 3, one on each side of the litter facing patient's shoulders, grasp the left and right poles respectively (fig. 150). At the command **LOAD** the litter is



Figure 149. Squad at "AMBULANCE POSTS."



Figure 150. "RIGHT UPPER BERTH PREPARE TO LOAD . . ."



Figure 151. LOAD.

lifted and carried to the ambulance. The front stirrups are placed in the grooves of the inclined upper berth (fig. 151) and No. 2 slides the litter up onto the berth (fig. 152).

He then grasps the berth rods and raises them so that the upper berth with its litter is level (fig. 153). No. 1 man then enters the ambulance and secures each litter handle with the strap attached to the berth for the purpose. He also fastens the roof straps to the upper berth (fig. 154). The squad then reassembles without command at **AMBULANCE POSTS**. The right lower berth is then loaded at the command **1. RIGHT LOWER BERTH PREPARE TO LOAD, 2. LOAD**. The litter is slid into place (fig. 155) and the handles secured by straps as before. The left side of the ambulance is then loaded in similar manner. Four litter patients is the normal capacity of the ambulance. However two additional litter patients



Figure 152. No. 2 sliding litter onto right upper berth.



Figure 153. No. 2 raising right upper berth into place.



Figure 154. No. 1 fastening straps to secure handles of litters



Figure 155. Loading right lower berth.



Figure 156. Four-litter ambulance showing how six-litter cases may be arranged (in emergency only).



Figure 157. Two litter and four sitting cases in ambulance.



Figure 158. Two litter cases in ambulance.

may be carried on the floor (fig. 156). When both litter and sitting cases are to be carried, they are loaded as in figure 157. When only two litter patients are to be carried, the lower berths are utilized (fig. 158). When loading is completed No. 1 raises the rear step (which forms a seat) and closes the rear doors. The loading squad then resumes positions at **AMBULANCE POSTS** without command.

b. **To unload ambulance.** To unload ambulance the command is: 1. **PREPARE AMBULANCE FOR,** 2. **UNLOADING.** At this command, No. 1 opens the rear doors, lowers the rear step, and releases the front straps securing the litters. Meanwhile Nos. 2 and 3 release the rear straps securing the litters. When this is accomplished, the squad resumes its position at **AMBULANCE POSTS** without command (fig. 159). To proceed with unloading the command 1. **RIGHT LOWER BERTH PRE-**

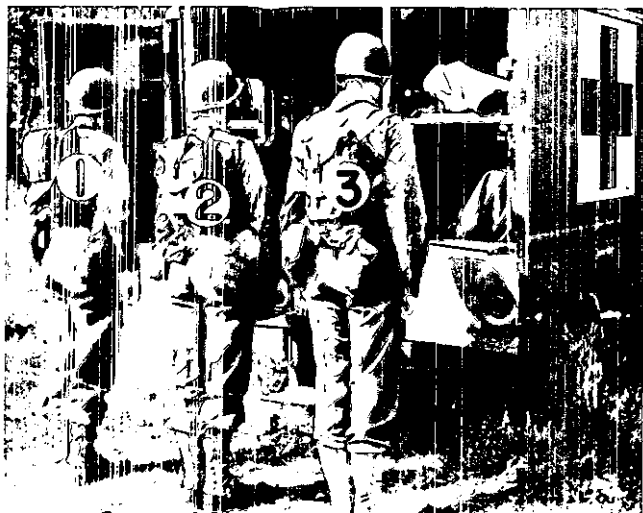

Figure 159. Squad at AMBULANCE POSTS ready to unload ambulance.



Figure 160. RIGHT LOWER BERTH PREPARE TO UNLOAD . . .



Figure 161. UNLOAD.



Figure 162. Depositing patient 3 paces to rear of ambulance.



Figure 163. No. 2 lowering upper berth preparatory to unloading.

PARE TO UNLOAD, 2. UNLOAD, is given. At the first command No. 2 grasps the rear handles of the litter in the right lower berth while Nos. 1 and 3 take their places on either side (fig. 160). At the command UNLOAD No. 2 pulls the litter from the berth while Nos. 1 and 3 grasp the litter poles toward the head end as it slides out (fig. 161). The three men then remove the litter at least three paces from the ambulance and deposit it on the ground (fig. 162). The squad then resumes its position at AMBULANCE POSTS without command. When the command RIGHT UPPER BERTH PREPARE TO UNLOAD is given, No. 2 man steps forward, pulls out the rods of the upper berth, squeezes them together, and lowers the berth to unloading position (fig. 163). At the command UNLOAD No. 2 pulls out the litter, Nos. 1 and 3 grasping it as before. The left side is unloaded similarly.

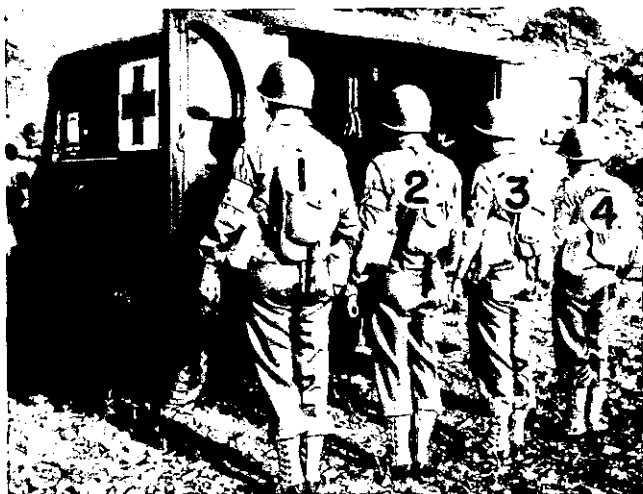

Figure 164. AMBULANCE POSTS.



Figure 165. RIGHT UPPER BERTH PREPARE TO LOAD . . .



Figure 166. LOAD.

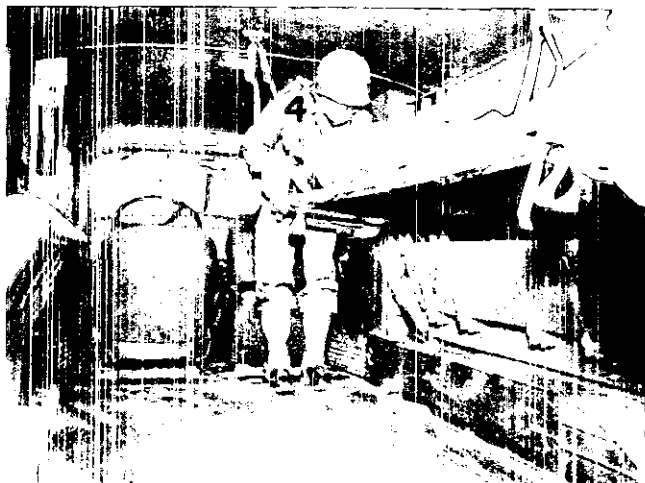

Figure 167. No. 4 securing front of litter inside ambulance.



Figure 168. Nos. 1 and 3 securing rear end of litter.



Figure 169. No. 1 closing doors of loaded ambulance.

89. AMBULANCE, 3/4-TON, 4x4. A squad of four men is needed to load or unload this ambulance. With four loaded litters in the immediate vicinity and the squad being at **AMBULANCE, POSTS**, the command, **OPEN, DOORS** is given. No. 1 advances, lowers the rear step, opens the doors and returns to his position at **AMBULANCE, POSTS** (fig. 164).

a. To load ambulance. to load ambulance the commands are: 1. **RIGHT (LEFT) UPPER (LOWER) BERTH, PREPARE TO LOAD**, 2. **LOAD**. The procedure is as follows:

(1) At the first command, bearers take position as follows: No. 2 at foot of litter facing patient, stoops and grasps handles; Nos. 1 and 3, one on each side of litter facing patient's shoulders, grasp the right and left poles, respectively (fig. 165).

(2) At the command **LOAD**, the litter is lifted by Nos. 1, 2 and 3 and advanced into the berth designated in the preparatory command (fig. 166).

(3) At the same command, the ambulance orderly or No. 4 if ambulance orderly is absent, from the front of the ambulance, assists in advancing the litter within the ambulance, and secures front handles in brackets, straps, hooks, or other device present (fig. 167).

(4) The rear handles are secured by Nos. 1 and 3 (fig. 168).

(5) Other berths are loaded similarly in this order: right upper, right lower, left upper, and left lower.

(6) Following the loading, preparation of the ambulance for departure, such as closing doors and raising step, is accomplished by No. 1 (fig. 169).

(7) When loading has been completed, squad resumes position at **AMBULANCE, POSTS** without command.

b. To unload ambulance. The squad being at **AMBULANCE POSTS**, and the ambulance being prepared for unloading, to unload ambulance, the commands are: 1. **RIGHT LOWER BERTH, PREPARE TO UNLOAD**, 2. **UNLOAD**. The procedure is as follows:

(1) At the first command, Nos. 1, 2 and 3 step forward and arrange themselves numerically, from right to left, at the foot of the litter; and No. 4 takes position within the ambulance, at the head of the litter.

(2) At the command **UNLOAD**, No. 2 grasps the projecting handles and draws out the right lower litter, assisted by Nos. 1 and 3, who, facing inward, support the poles. The litter is removed and placed three paces to the rear of the ambulance, and the squad resumes its positions at **AMBULANCE POSTS** without command.

(3) The right lower berth being unloaded and the appropriate command given, Nos. 1 and 3 free the rear, No. 4 the front, handles, of the right upper litter; then all three lower the litter to the floor and the squad proceeds as in unloading a lower berth. The left side is unloaded similarly.

CHAPTER 5

CONVERSION OF COMMON MILITARY VEHICLES TO PATIENT CARRIERS

90. **GENERAL.** a. Many common military vehicles can be converted into patient carriers with little or no structural change. Often in combat areas ambulances will be unavailable, too few in number, or incapable of evacuating certain regions due to the tactical situation or difficulties arising from the terrain. In such cases it becomes necessary to utilize whatever vehicles are available to transport the wounded. Methods of using several of the more common military vehicles to carry casualties are described in this chapter.

b. Most of these vehicles are not inclosed. In order to insure that the casualty does not bounce off the litter in transit, he should always be bound to the litter prior to loading on the vehicle. Straps to be used for this purpose and known as litter-securing straps are an item of issue (par. 76).

c. To insure that the litters themselves will not bounce off the vehicles, it is necessary that they be lashed securely to the sides of the various trucks after being loaded. For this purpose lengths of rope, litter straps, or any other convenient materials may be used.

d. In general, litters will be loaded as follows: when litters are lengthwise to the vehicle, patients' heads will be towards the front; when litters are loaded crosswise, patients' heads will be alternately right and left to minimize discomfort to adjacent patients in cases of nausea and vomiting.

91. THE 1/4-TON TRUCK AND 1/4-TON TRAILER.

The 1/4-ton truck (jeep or peep) and trailer are standard equipment of medical battalion sections and many other units of the Army. They will be available almost always and are easily adapted to carrying casualties.

a. Two litter patients can be carried on the 1/4-ton truck without alteration in the vehicle or the use of additional equipment (fig. 170). One litter is placed across the back of the truck, handles of the litter resting on the truck sides. The second litter is placed lengthwise on the right side of the truck. The rear handles of the second litter rest on the side of the first litter, and the front stirrups fit in the groove below the windshield.

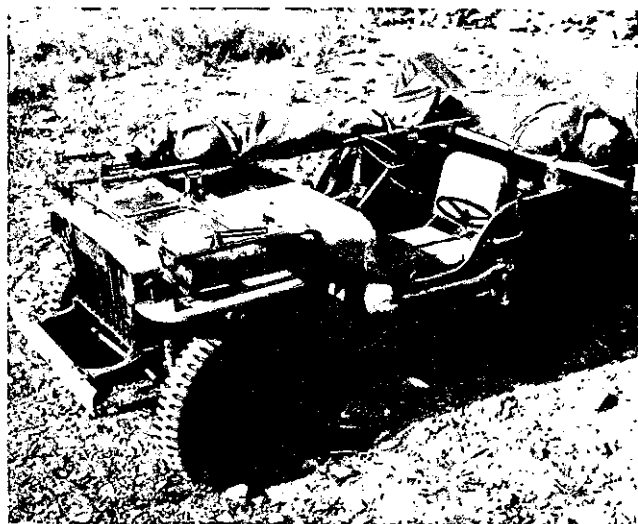

Figure 170. The 1/4-ton truck loaded with two litter patients.

b. A disadvantage to the method of transportation described in a above results from the necessity of placing the first litter crosswise to the truck. When the route

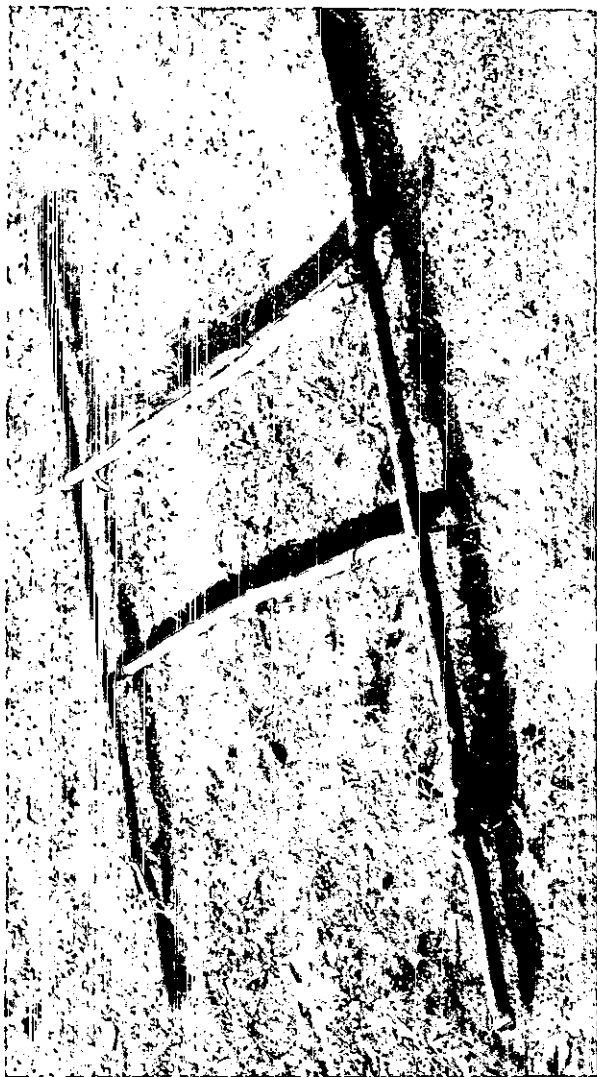

Figure 171. Improvised sapling frame for 1/4-ton truck.

of evacuation is along narrow roads or trails, there is danger of the litter handles catching on projecting trees and bushes. This danger can be obviated by construction of an improvised pole or sapling frame to permit carrying of two litter casualties lengthwise on the rear of the truck. Such a frame can be made by binding together four poles, saplings, or boards in the shape roughly of a two-rung ladder (fig. 171). The frame is lashed to the side handles of the jeep with ropes or straps and the top bows lashed to the frame in back. The litters are loaded with patients' heads toward the front. The fronts of the litters rest on the front crosspiece of the frame, and the backs of the litters on the bows of the truck (fig. 172)

c. A more permanent board frame may be made from salvaged 2 by 4's or similar material (fig. 173). An advantage of this type of frame is that it can be folded up



Figure 172. Two litters loaded on improvised sapling frame.

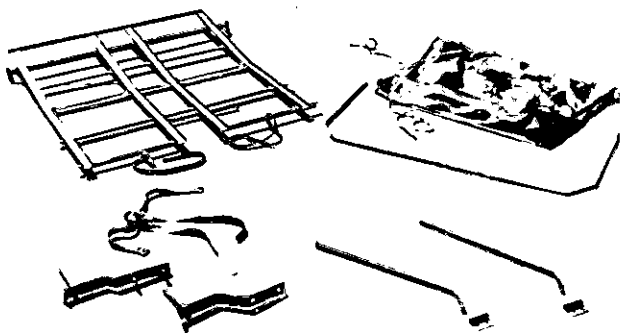

Figure 174. Two litters loaded onto board frame.

and stored when not in use. When mounted on the truck, the crosspiece of the frame is placed in position just behind the backs of the front seats. The side pieces of the frame extend to the rear and slightly inward over the corners of the truck. These pieces support the truck bows which are slid to the rear where they fit into a notch and are lashed to the side pieces. When the litters are loaded onto the truck, they are supported in front by the crosspiece of the frame, and in the rear by the truck bows (fig. 174).

d. Litter carrier for $\frac{1}{4}$ -ton truck. This metal carrier is issued to convert, without any permanent changes, the $\frac{1}{4}$ -ton truck into a two-litter ambulance. To mount the carrier on the truck, the spare tire and gasoline can together with their racks must be removed. The back of the rear seat must be folded down over the seat. The spare tire is then mounted between the backs of the front seats on special brackets (A, fig. 175) which are slid into the foot rests on each side of the floor in back. The tire is steadied by straps. The outside pair of bolts on the two rear bumpers are then loosened and one of the small fittings (B, fig. 175) bolted under each bumper to support the frame braces (C, fig. 175). When these changes have been made, the truck can still be used for its original purpose. The litter frame, which folds in the middle (D, fig. 175), can then be mounted or removed in a minute or two. It is fitted over the back of the truck, the joint of the frame fitting over the rear plate of the truck. Braces (C, fig. 175) support the back end of the frame. A bow (E, fig. 175) fits into the frame to support the canvas top (F, fig. 175). Litters are then slid into the tracks on the frame. They should be bound to the frame and patients secured to the litters with litter securing straps.

e. The $\frac{1}{4}$ -ton cargo trailer may be readily adapted to the transportation of litter casualties (fig. 179). Two litters are placed lengthwise on the trailer, with the litter stirrups fitting inside and thus preventing the litters from falling off. The litter handles are bound to the small hooks on the side boards of the trailer.



- a. Brackets and straps for spare tire*
- b. Fittings to support frame braces*
- c. Frame braces*
- d. Litter frame*
- e. Top bow*
- f. Canvas top*

Figure 175. Parts of litter carrier for 1/4-ton truck.

f. By attaching the loaded 1/4-ton cargo trailer to the 1/4-ton truck, four casualties may be transported. The method of litter loading described in paragraph a above must ordinarily be used to load the 1/4-ton truck, as use of either the improvised or permanent frames on the rear of the truck would make it impossible to attach the trailer.

g. If it is thought desirable, a frame for two litters on the front of the truck may be constructed, thus making it possible to attach the trailer, and transport four

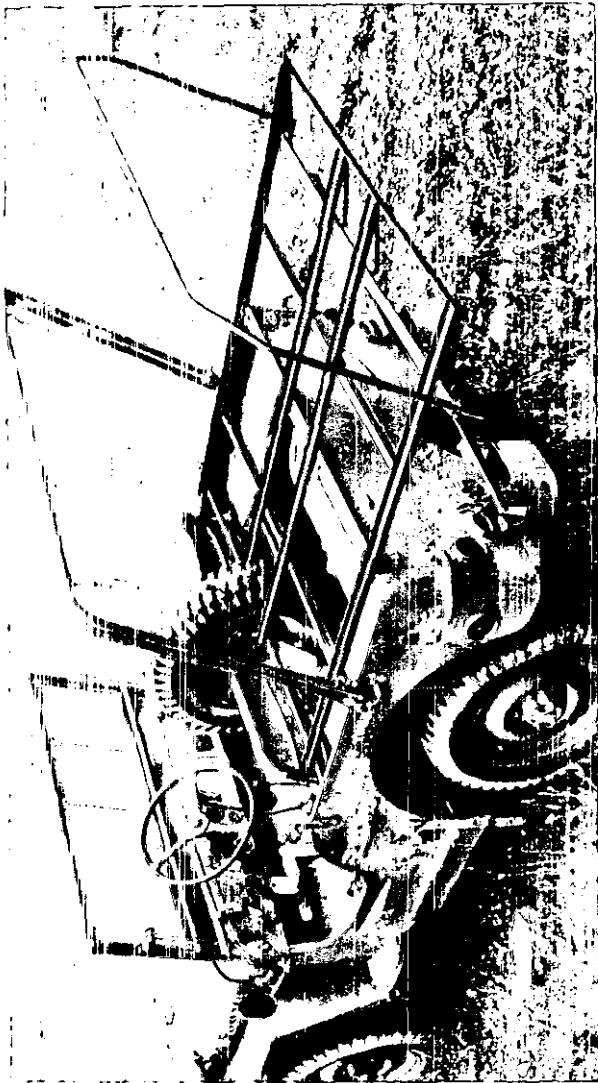

Figure 176. Litter carrier for $\frac{1}{4}$ -ton truck mounted.

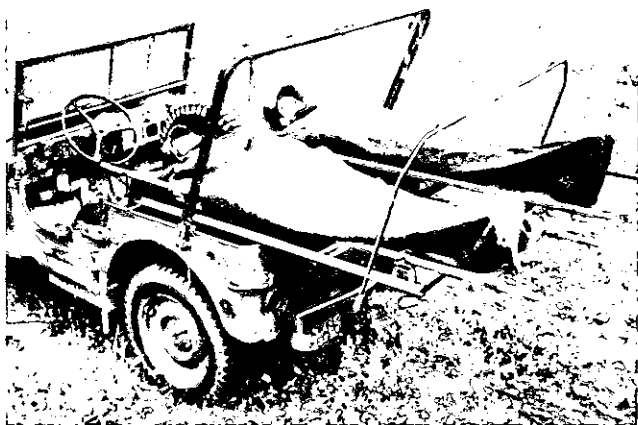

Figure 177. Litters in place.



Figure 178. Installation of litter carrier completed.

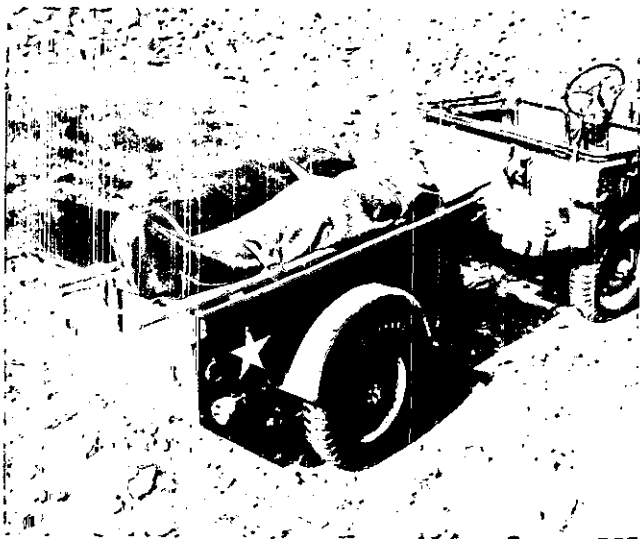
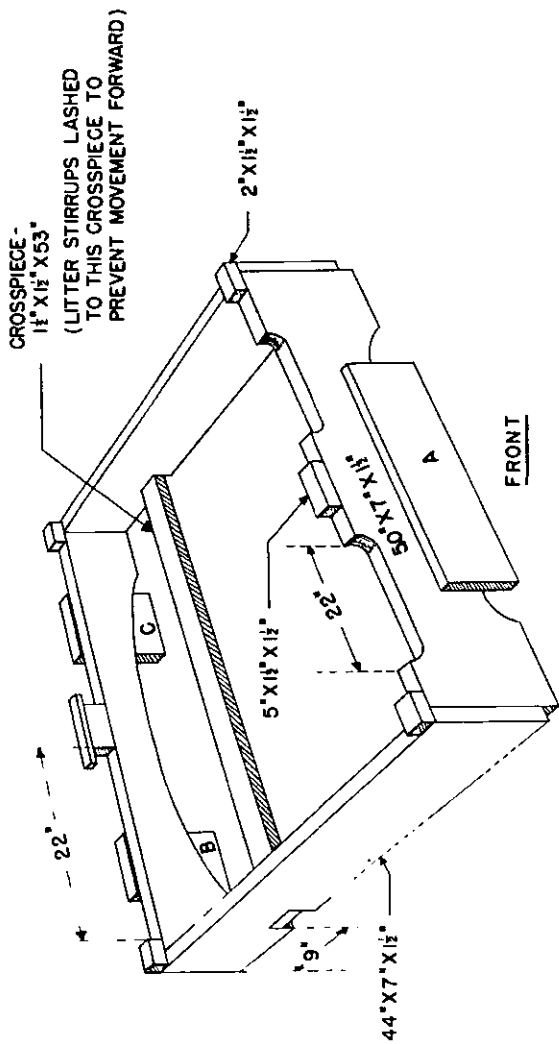

Figure 179. 1/4-ton cargo trailer loaded with two litters.

patients in a position lengthwise to the truck (fig. 180). The frame is placed on the hood of the truck, and the litters loaded lengthwise. The rear handles of the litter extend over the dashboard with the outer handles lashed to eyebolts on the dashboard directly below. Patients' heads are toward the truck body to minimize the danger of accidents during transport (fig. 181).

92. THE 3/4-TON TRUCK AND 1 1/2-TON 6x6 TRUCK. a. The 3/4-ton truck (weapons carrier) is a common vehicle both in the infantry and in medical units. It is easily adapted for use as a patient carrier. Two litters are placed lengthwise and head foremost in the bottom of the 3/4-ton truck, their ends protruding and supported by the tail gate. The protruding ends are bound with ropes to prevent the litters from sliding out. If the roof bows of the truck are off, a second layer of three litters is placed side by side crosswise, resting on



BLOCKS "A", "B", "C" PREVENT MOTION OF THE RACK TO FRONT OR REAR.

Figure 180. Plan of hood frame for 1/4-ton truck.

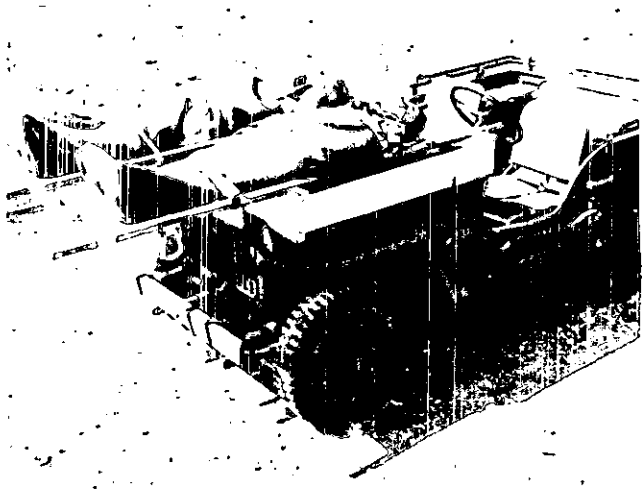

Figure 181. Hood frame loaded with two litters.

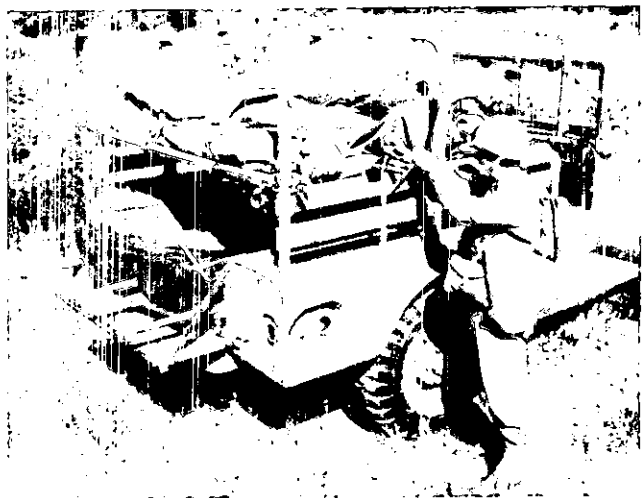

Figure 182. 3/4-ton truck loaded with five litters.



Figure 183. The 1 1/2-ton 4x4 truck loaded with ten litters.

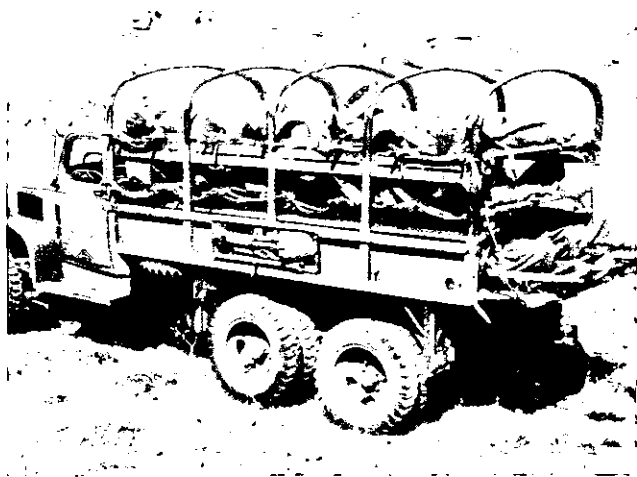

Figure 184. The 2 1/2 ton truck loaded with eighteen litters.

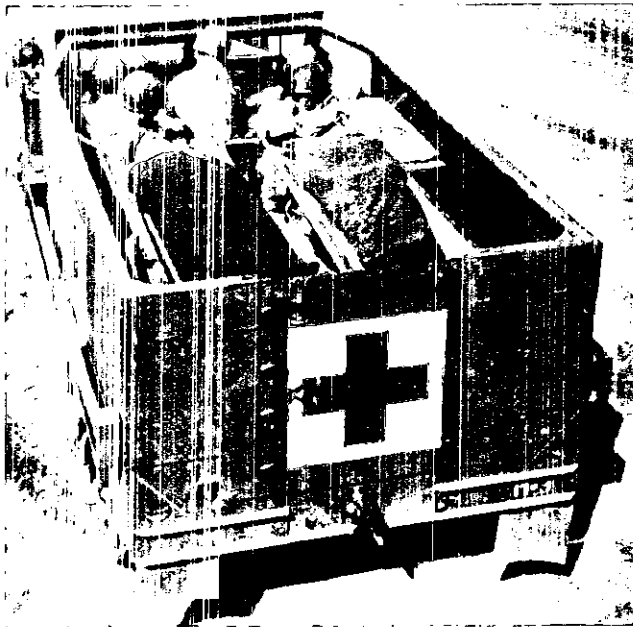

Figure 185. Half-track loaded with four litter patients plus medical personnel.

the seats and lashed in place. If the roof bows of the truck are in position, the second layer of litters is placed crosswise so that the litter handles rest on the bow braces. The handles of the center litter straddle the center bow. The litters of the top layer are secured by lashing their handles to the bow braces (fig. 182); thus, a total of five litter casualties can be transported.

b. The 1½-ton 6×6 truck is loaded similarly; that is, two litters lengthwise along the floor and a second layer crosswise over the bow braces. Because of the additional length of the truck body, however, five litters can be accommodated on the second layer, making a total of seven in the truck.

93. THE 1½-TON 4×4 TRUCK. The 1½-ton 4×4 truck, a common vehicle in many organizations, is also easily adapted as a patient carrier. This truck can accommodate three layers of litters. The bottom layer consists of two litters placed lengthwise on the floor. The middle layer of four litters is placed crosswise resting on the seats of the truck, and the top layer crosswise on the bow braces. The truck is loaded from front to rear, top layer first, then middle layer, top layer, and middle layer in alternation until the two upper layers are filled. Then the two litters on the floor are slid in from the rear. The tail gate is raised and fastened, and the litters of the two upper layers are secured to the seats and bow braces by straps (fig. 183). Thus the capacity of the truck is ten litters.

94. THE 2½-TON TRUCK. The 2½-ton truck, another vehicle of wide general use, is loaded similarly to the 1½-ton truck but has a greater capacity. The upper, middle and bottom layers are again placed on the bow braces, on the seats, and on the floor, respectively. The floor of the truck will accommodate six litters in two rows of three litters each loaded lengthwise to the truck in the following manner: the two side litters are placed on the floor first and then slid sideways until they are under the seats. The center litter is placed between the two. The back three litters protrude from the floor of the truck and are supported by the tail gate which cannot be closed. The entire truck is loaded from front to rear in any convenient order, care being taken not to obstruct the placing of one litter by premature loading of another. Finally, the litters are bound securely to the bow braces and the tail gate raised slightly above the horizontal to prevent sliding of the bottom litters. The truck when fully loaded permits transportation of eighteen litter patients (fig. 184).

95. THE HALF-TRACK. The half-track is a common vehicle in the armored units and may be used as an ambulance for armored force medical units. When so



Figure 186. Half-track converted for patient carrier.

employed, it will conveniently accommodate four litter patients, plus four slightly wounded patients or medical attendants (fig. 185). The litters are loaded in layers of two litters each lengthwise to the vehicle body. Certain structural changes (fig. 186) in the vehicle are required to support the litters as follows. U-shaped brackets are mounted on the gun pedestal to support the inner front handles of the four litters. Rings are suspended from chains fastened to the vehicle back- and side-plates to support the inner rear handles of the four litters, as well as the outer front handles of the two top litters. The outer rear handles of the two top litters are supported on brackets welded to the rear plates. The outer front handles of the two bottom litters rest on the vehicle seats.

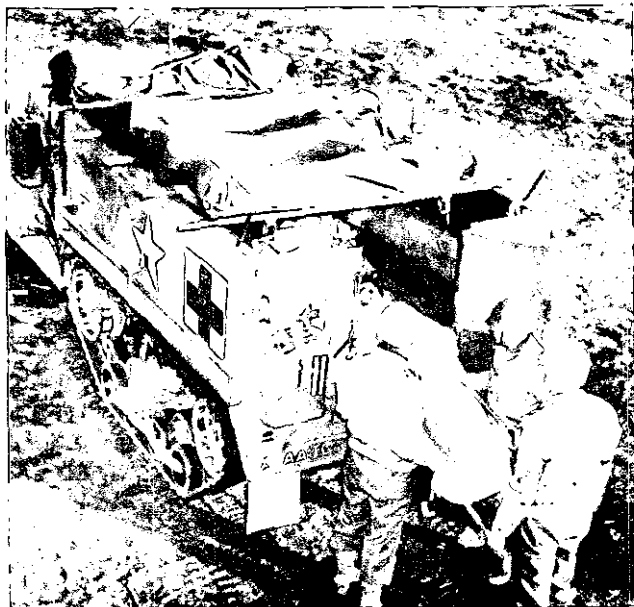

Figure 187. Loading half-track (alternative method).

a. An alternative method of loading the half-track may be employed when it is not considered desirable or feasible to make structural changes in the vehicle itself (fig. 187). Five litters are mounted across the top of the half-track, then an additional litter is slid lengthwise into the vehicle on the floor. A disadvantage of this method results from the difficulty of lashing the five top litters in place. However, this can be accomplished if sufficient rope or other suitable material is available.

b. In cases of emergency, nine litter patients can be transported in the half-track by combining the two methods described above. The required structural changes must first be made, after which four litters are loaded into the vehicle. Then five additional litters are loaded crosswise on the top of the half-track.

96. THE 2½-TON AMPHIBIAN TRUCK. The 2½-ton amphibian truck (duck) can be adapted as a patient carrier. The vehicle will usually be available only to troops engaged in or contemplating amphibious operations. It is most useful in transferring casualties from shore landing parties to ships nearby. The same truck that brings supplies to the shore may carry wounded men back to the ship. The truck may be loaded at the unit aid station, then driven down to the shore and out to the ship, or it may be loaded at the water's edge (fig. 188). To convert the 2½-ton amphibian truck to a patient carrier the bows are first loosened and slid forward where they are bound in place against the front bow. Five litters can then be placed on the bottom of the truck, two crosswise in front, and three lengthwise in the rear (fig. 189). In order to rest litters on the sides of the truck and thus make a second layer, it is necessary to construct a rail along each side of the truck just outside and above the side (fig. 190). This rail is



Figure 188. Loading the 2 1/2-ton amphibian truck.

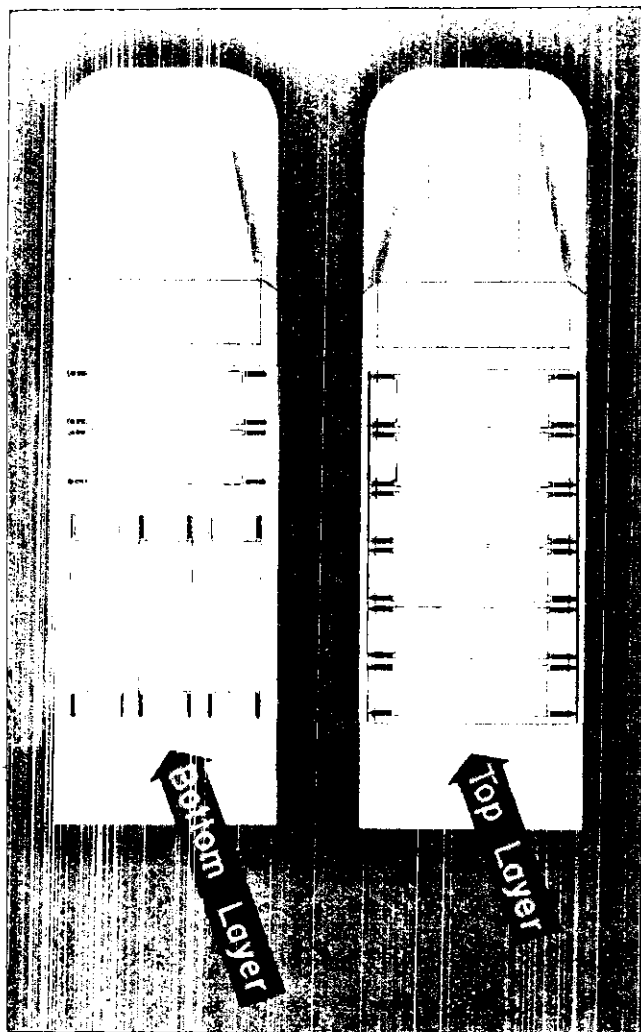

Figure 189. Plan of loading litters in the 2½-ton amphibian truck.

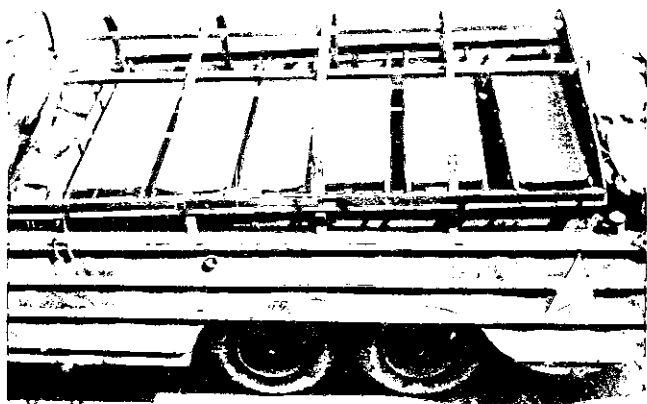

Figure 190. Top layer of litters held in place by side rails.

held in place by a special bracket which clips on the side of the truck. When litters are placed across the sides of the truck, their handles abut against the rail, preventing the litters from sliding off. Six litters can be loaded side by side across the top. The capacity of the truck fully loaded is eleven litter casualties, five on the bottom and six on top. All litters must be tied securely in place so that they will not slide around or be displaced by rocking of the truck in rough water.

97. LANDING CRAFT. For the use of landing craft as patient carriers, see chapter 8.

CHAPTER 6

RAIL TRANSPORTATION

98. **GENERAL.** a. **Status.** Hospital trains are trains constructed or converted for the rail transportation of sick and wounded. The Medical Department is charged with furnishing medical personnel and medical equipment for such trains and with their general administration. As railway units they are operated and maintained mechanically by the Transportation Corps in the theater of operations. Trains in the zone of the interior are operated by the railroads, and maintained mechanically by the Transportation Corps.

b. **When employed.** Railway transportation for the sick and wounded will be used whenever feasible unless other available means are considered preferable.

c. **Where employed.** Normally the extreme limits of rail evacuation are a railhead in the army area and a general hospital in the zone of the interior. Within these limits other means such as airplanes and ships will be employed to supplement rail transport. Under exceptional circumstances wherein the military situation has become stabilized and railways have been placed in operation for the supply of troops in forward areas of the combat zone, evacuation of divisions by rail transportation may be practicable.

d. **Means of transport.** For evacuation of army and rearward installations, hospital trains will be utilized. For evacuation of division areas, any available rail transport will be used.

e. **Selection of patients.** (1) *Zone of the interior.* Patients will be transferred to hospitals in the zone of the interior according to the following considerations:

(a) Patients will be sent to general hospitals specializing in the treatment of the specific type of casualty from which they suffer; for example, neuropsychiatric, surgical, malarial, etc.

(b) Patients will be sent in so far as practicable to the general hospital closest to their homes.

(2) *Theater of operations.* Within the theater of operations, patients will be transported by hospital trains according to the following considerations:

(a) Capability of the patient to withstand the trip.

(b) Number of vacant beds in the hospital to which the train is evacuating casualties.

(c) The probable eventual disposition of the patient; for example, patients should not be evacuated to a port of debarkation unless their return to the zone of the interior is considered probable.

99. NON-STANDARD HOSPITAL TRAINS. a. Composition. The composition of improvised hospital trains will depend on the number and type of patients to be transported and the rolling stock available.

(1) Cars suitable for employment within the zone of the interior are:

(a) *Standard Pullman sleepers.* Standard Pullman sleepers are capable of transporting from 20 to 24 patients, including 10 to 12 litter cases. Litter cases should be placed in lower berths only, except in cases of emergency, as placing them in upper berths not only presents great difficulties in loading, but also makes treatment enroute more difficult. Sleeper berths may be used or hospital beds installed. Compartments for quartering duty nurses are also available.

(b) *Tourist sleepers.* Tourist sleepers may also be used without structural change. They are capable of accommodating 26 patients, including 13 litter cases. They lack the comfort and privacy of the standard sleepers. Hospital beds may be installed.

(c) *Standard chair cars.* Standard chair cars may be used without structural change for the transportation of sitting cases. Their conversion for the accommodation of litter cases may be accomplished by removing the chairs and installing 2-or 3-tiered beds, such as the Glennan bunk. The Glennan bunk is 2-tiered and consists of a metal frame arranged for bolting to the floor and wall, which supports a mattress and springs of a hospital bed fitted with side hinges and straps. The upper tier may be used for a patient, or folded against the wall as a back rest for patients sitting on the lower tier.

(d) *Standard baggage cars.* One baggage car for each improvised hospital train is required for the purpose of transporting baggage and equipment of patients and duty personnel, and surplus medical and other supplies.

(e) *Kitchen cars.* One or more medical kitchen cars are provided when a trip of considerable distance is contemplated. Each kitchen car is divided into a kitchen and dining room. Patients are fed on trays in the ward car.

(f) *Ward cars or ward cars, modified.* Ward cars are capable of transporting 28 patients in two-tier bunks. Each car contains a dressing table, sterilizer, and instrument cabinet. In addition cars may be modified to include a buffet kitchen with range, sink, and refrigerator, capable of accommodating 28 to 30 patients for a few meals.

(g) *Unit cars.* Unit cars are of sufficient size to transport 30 patients on three-tier bunks, plus six medical soldiers or mental patients and a medical officer and nurse. Cars contain rudimentary surgical facilities, as well as sufficient cooking facilities to feed 60 to 70 patients for a few meals. In addition to being used as part of a hospital train, the unit car may also be attached to commercial trains on regularly scheduled runs.

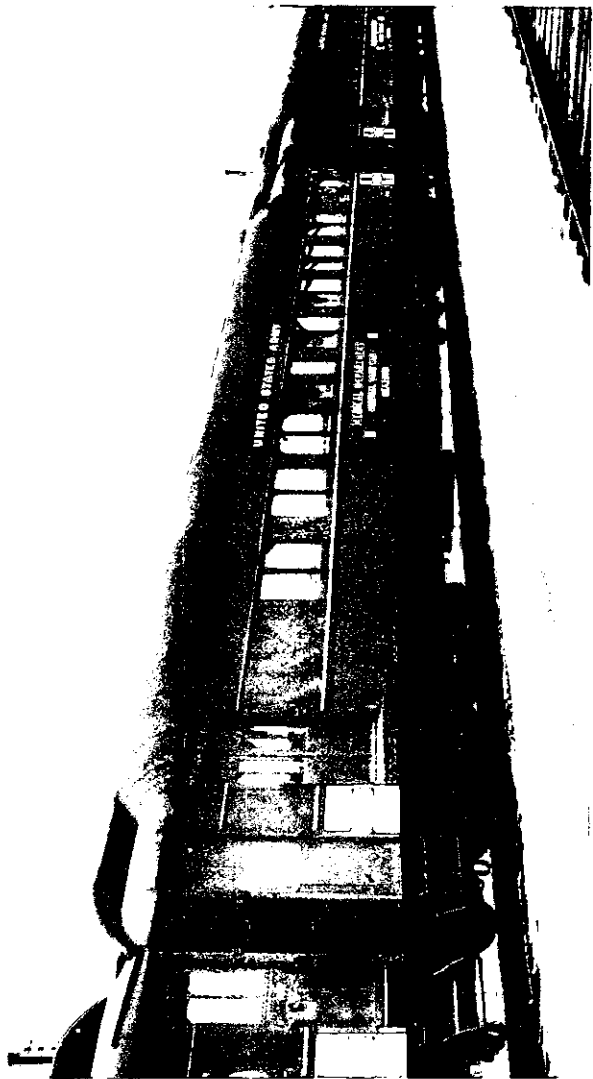

Figure 191. Exterior view of ward car.

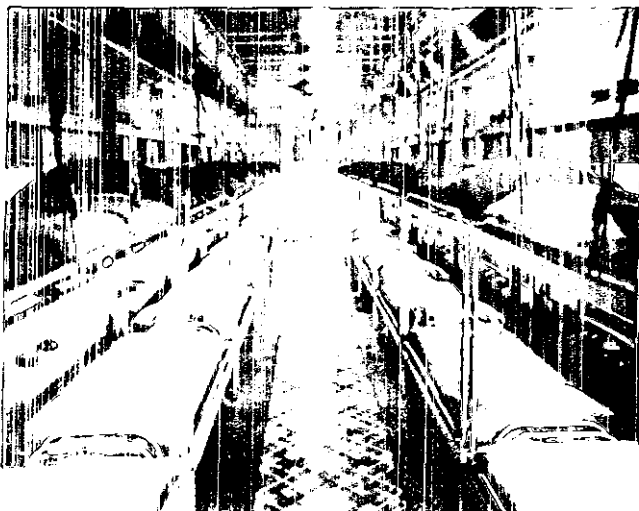

Figure 192. Interior view of ward car.

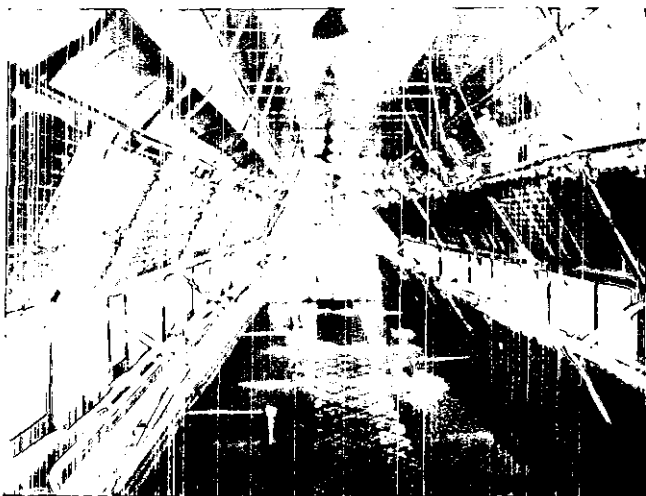

Figure 193. Interior of ward car ready for cleaning.



Figure 194. Interior of ward car made up for use of sitting patients.

(2) Within the various theaters of operations, the types of railroad cars available for improvising hospital trains will vary so widely that no description can be attempted. However, the train commander and his assistants should assure themselves that patients are made as comfortable as possible under existing local circumstances.

b. Assembling improvised train. In the zone of the interior hospital trains will be so assembled at the debarkation hospital that cars may be detached at various points en route until all patients have reached their proposed destinations. Any practicable combination of cars listed in a (1) above will be used. The number of patients per train will depend upon the types of cars used, the kinds of casualties being transported, and the number



Figure 195. Interior of unit car.

of Medical Department personnel required to care for patients en route. The usual train will consist of 16 to 20 cars and accommodate from 150 to 250 patients. Ordinarily no train will be moved within the zone of the interior with less than 100 first class fares. However, individual cars carrying patients may be attached to commercial trains operating on regular schedules when feasible.



Figure 196. Hospital train being loaded (Italy).

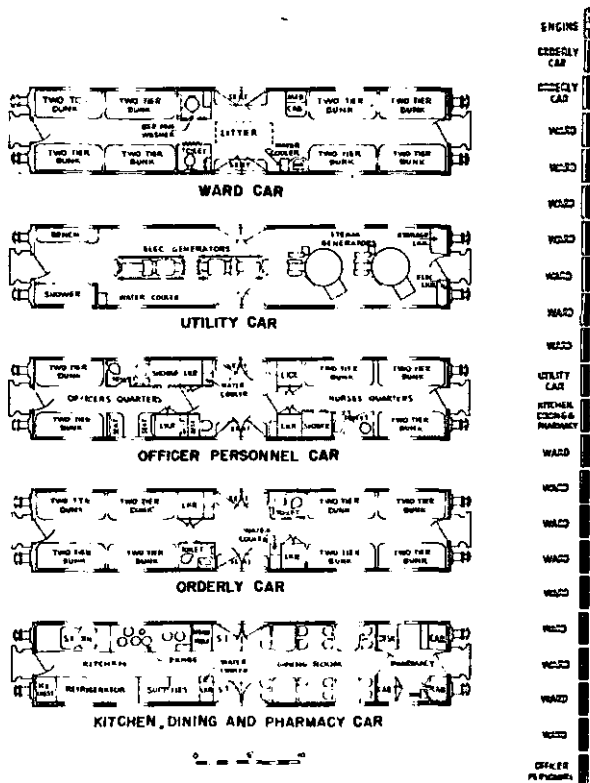

Figure 197. Plan of standard hospital train.

100. STANDARD HOSPITAL TRAIN. a. General. Standard hospital trains (operating under T/O & E 8-520) are employed in the theater of operations whenever available. They may also be used in the zone of the interior in lieu of improvised trains.

b. Composition. The standard hospital train consists of 21 cars described as follows:

(1) *Sixteen ward cars.* Each ward car has eight double bunks, thus accommodating sixteen bed patients. In the center of the car are two seats on which ambulant patients and ward personnel can sit. Equipment includes a toilet, bed-pan washer, sink, and medicine cabinet.

(2) *One utility car.* The utility car has two large electric generators, two large steam generators, storage lockers, showers, and other facilities.

(3) *One officer personnel car.* This car is divided into two sections. At one end are two double bunks for four officers, at the other three double bunks for six nurses. Separate latrine and shower facilities are in the center.

(4) *Two orderly cars.* Each of these two cars contains bunks, latrines, and shower facilities for sixteen Medical Department enlisted men.

(5) *Kitchen, dining, and pharmacy car.* This car is divided into three sections. At one end are kitchen and food storage facilities for preparation of food for patients and hospital train personnel. In the center are tables for sixteen diners. At the other end is a small pharmacy with sink, shelves, and cabinets.

CHAPTER 7

AIR TRANSPORTATION

101. GENERAL. a. **Definition.** Air evacuation is the transportation of the sick and wounded by military aircraft, equipped for quick conversion for the requirements of air evacuation.

b. **Increased difficulty of evacuation.** Motorization, mechanization, and aviation have increased the tempo of modern warfare. Concepts of distances have shrunk and, frequently, lines of communication are long and insecure. For evacuation to keep apace, every available means must be employed. Evacuation by air will be utilized whenever feasible. The most important factor in the successful employment of such means is air superiority.

102. ADVANTAGES OF EVACUATION BY AIR. a. **Strategic value.** (1) The removal of patients by air from theaters or bases greatly reduces the quantity of medical supplies, hospital equipment, food, and other class I supplies, and the number of medical and non-medical personnel that it is otherwise necessary to transport to the theater or base. From 250 to 650 patients, depending upon the type of transport airplane employed, can be removed to the zone of interior from a theater 3,500 miles away by the use of 20 transport airplanes in less than 48 hours. Yet, to hospitalize this number of patients requires several train or ship loads of equipment initially, and many tons of all classes of supplies each week for the care and maintenance of patients and medical personnel, with additional requirements of a large number of Medical Department officers, nurses, and enlisted men.

(2) The strategic importance of air evacuation must be borne in mind by all theater and task force commanders, and by all officers concerned with the preparation of plans for military operations.

b. Speed. The attainable speed of air transport will decrease evacuation time and reduce the number of fatalities incident to transportation, providing that, under medical supervision, cases for evacuation are properly selected prior to, and properly care for during, the actual movement.

c. Comfort of patients. In general, no other mode of transport approaches the degree of comfort offered the patient by the airplane. The discomfort, and actual danger involved in certain types of cases, may be circumvented by low altitude flying or by the administration of oxygen en route.

d. Safety. The airplane, if air superiority is maintained, represents the safest means of transport and, if cases for movement be selected properly, the safest method of transportation.

e. Morale. The morale of the entire fighting force is markedly elevated by the knowledge that by aircraft they can be removed, if wounded, to a hospital where excellent medical facilities are available within a matter of a few hours, rather than days.

f. Treatment en route. In aircraft converted for transportation of casualties, considerable treatment can be administered en route. Examples: readjustment of splints; administration of stimulants, sedatives, plasma, and other medication; arrest of hemorrhage; treatment of shock; and most important of all, administration of oxygen, when indicated.*

*All aircraft intended for purposes of evacuation are equipped with apparatus for the administration of oxygen.

g. **Medical supplies.** Aircraft utilized for evacuation are employed, in their forward movement, for delivery of supplies, including medical supplies, to units functioning in the combat zone.

h. **Redistribution of the medical task.** Institution of evacuation by air within the combat zone will transfer the heavier treatment load from mobile installations of the combat zone to fixed installations of the communications zone or zone of the interior.

i. **Evacuation, where otherwise impossible.** Casualties are evacuated by air from islands, isolated and other inaccessible localities, and across water, from which land or sea transportation is inadequate or impossible.

103. AREAS OF EMPLOYMENT. a. **Theater of operations.** Within the theater of operations, two echelons of evacuation by evacuation airplane are contemplated.

(1) *Within the combat zone.* Division clearing stations and other medical installations within the combat zone may be located as near as feasible to landing fields. Even the location of potential landing fields must be considered by clearing elements in the selection of the location for their installations. Air force officers should be consulted as to suitable fields. From these fields, cases from clearing stations and other medical installations are evacuated by light evacuation airplanes or helicopters which require only a flight strip or open field upon which to land and take off. From here, casualties are evacuated to larger fields in the area near designated army hospitals (evacuation, field, or convalescent hospital).

(2) *From combat to communications zone.* At landing fields in the vicinity of army hospitals casualties are collected for air evacuation further to the rear. Large transport aircraft of the troop carrier squadron, reinforced by medical elements of the air evacuation medical squadron evacuate these casualties to hospitals in the communications zone. Receiving hospitals in the communications zone are preferably port hospitals, or hos-

pitals located at or near Air Transport Command air bases from which further evacuation by sea or air to the zone of interior can be readily accomplished.

b. **Zone of the interior.** (1) *From theater of operations.* If the theater of operations and zone of the interior are contiguous, or separated by a small body of water, large evacuation airplanes may evacuate sick and wounded from either the combat or communications zone of the theater directly to the zone of the interior. In this event, incoming evacuation airplanes proceed to one conveniently located central field or to one of several fields located in the vicinity of convalescent, regional or general hospitals.

(2) *Within zone of the interior.* In the event that casualties from the theater of operations are brought to large reception centers by airplane or other means of transport, evacuation airplanes are then utilized for distribution of such cases to various general hospitals within the zone of the interior. Furthermore, casualties occurring within the zone of the interior itself, either because of the peculiar nature of the case or the isolated character of its geographical location, may be evacuated by evacuation airplane to civilian or military medical centers.

104. TYPE PATIENT FOR EVACUATION BY AIR.

a. **General.** Whenever possible, flight surgeons or flight nurses will be consulted as to the advisability of evacuating patients by air giving due consideration to all possible aero-medical problems involved. It is necessary that closest liaison be maintained between the flight surgeon of an air evacuation unit and the surgeon of the ground force installation being evacuated.

b. **Contraindications to evacuation by air.** The actual existence of a contraindication will depend upon the circumstances, bearing in mind the facilities available for treatment, means available for evacuation, the logistical problem, and the military situation, all of which must be professionally considered. Air evacuation, because of the rapidity and comfort, plus the presence

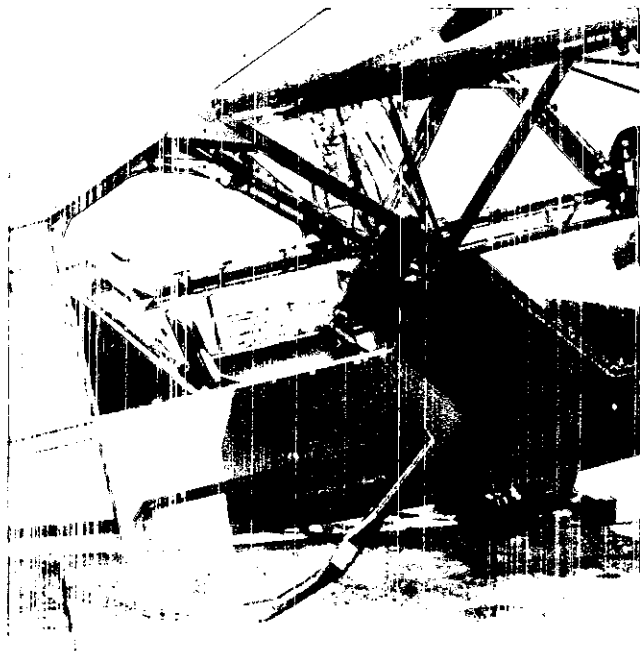

Figure 198. A liaison airplane showing passenger's seat.

of specially trained medical attendants, is generally the method of choice.

c. **Evacuation by air in emergencies.** In emergencies, air transport being available and evacuation by air being feasible, all cases, regardless of type, will be evacuated by air.

105. AIRPLANES TO BE USED FOR EVACUATION.

a. **Types.** The Army Air Forces has no aircraft designated to be used exclusively for ambulance purposes. Many aircraft are currently in use for the transportation of cargo and personnel to the various theaters of operations

and into the combat zones. The utilization of these as patient carriers on the return trips provides an air evacuation system capable of transporting large numbers of sick, wounded and injured. All suitable types of military aircraft have been permanently equipped with standard litter support fittings facilitating rapid conversion for temporary use as patient carriers. These aircraft bear no red cross markings and may be subject to enemy attack. Proper fighter protection must be provided when near enemy territory.

(1) Light liaison aircraft have been designed to carry litter patients or urgently needed medical supplies behind the pilot without affecting the primary function of the aircraft. This type of airplane may be used to evacuate clearing stations or other installations where no air fields (but a small level field) is available.

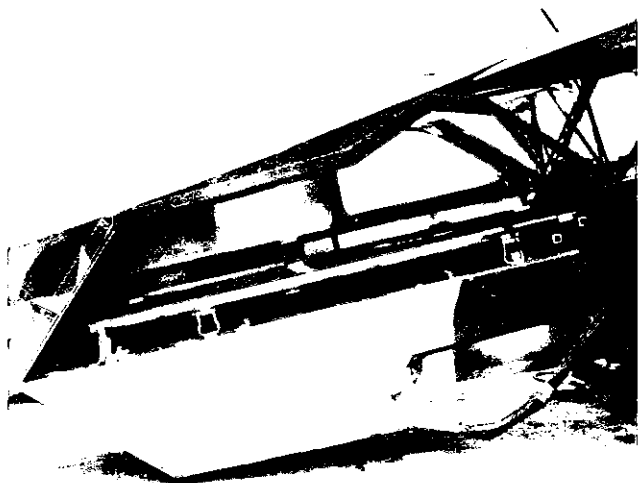

Figure 199. Liaison airplane loaded with litter.



Figure 200①. A helicopter used to evacuate casualties. The patients are carried in "capsules" outside the cabin.

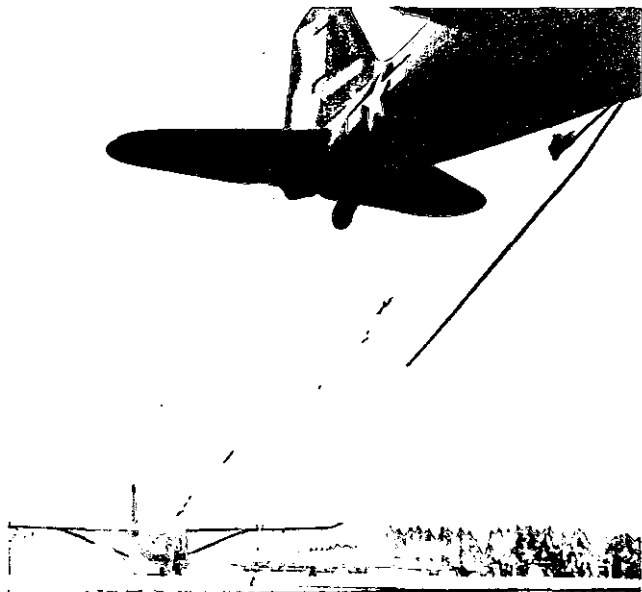

Figure 200③. A glider being picked up by a tow-airplane in flight. This procedure permits evacuation of casualties from fields which are unsuitable for the landing of airplanes.

(2) A helicopter may be used to evacuate patients from places where no landing field is available. This type of aircraft can descend and rise vertically, needing only a small spot to land. All suitable types will be equipped to transport litter patients, either in standard litter capsules attached outboard or in standard litter supports within the fuselage.

(3) Gliders are snatched from the ground by a tow-airplane in flight, using much the same pick-up equipment as is used in picking up messages from the ground by liaison aircraft.



Figure 201. A light transport.



Figure 202. Interior of a light transport fitted to carry litter patients.

(4) A light transport airplane capable of transporting, besides the operating personnel, 2 to 4 litter cases and 1 medical officer or enlisted attendant.



Figure 203. The C-47.

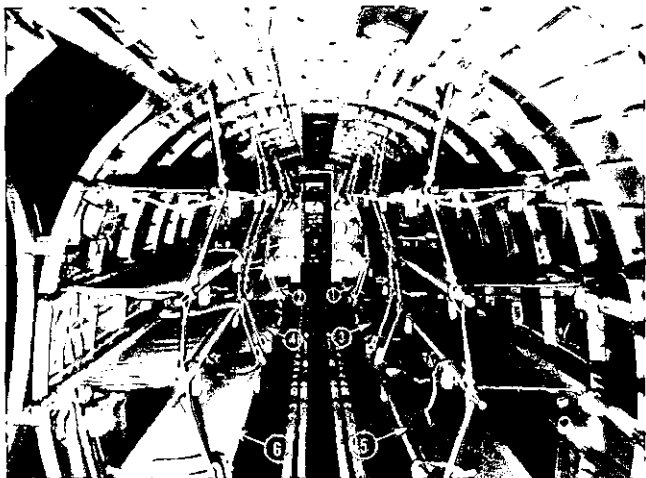

Figure 204. Interior of the C-47 fitted to carry litter patients.

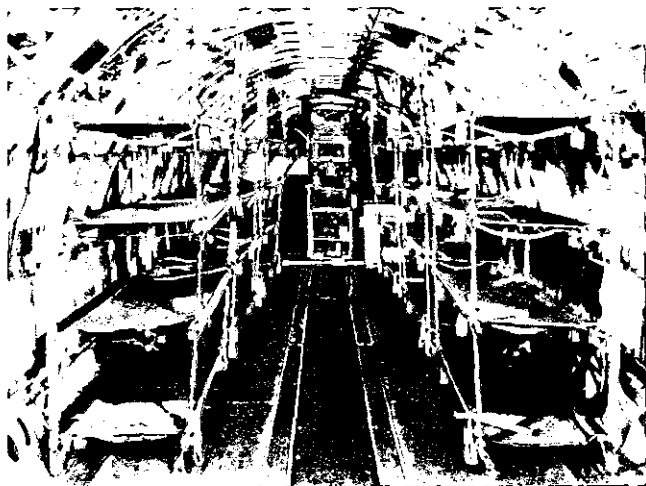

Figure 205. Interior of C-46 fitted to carry litter patients.

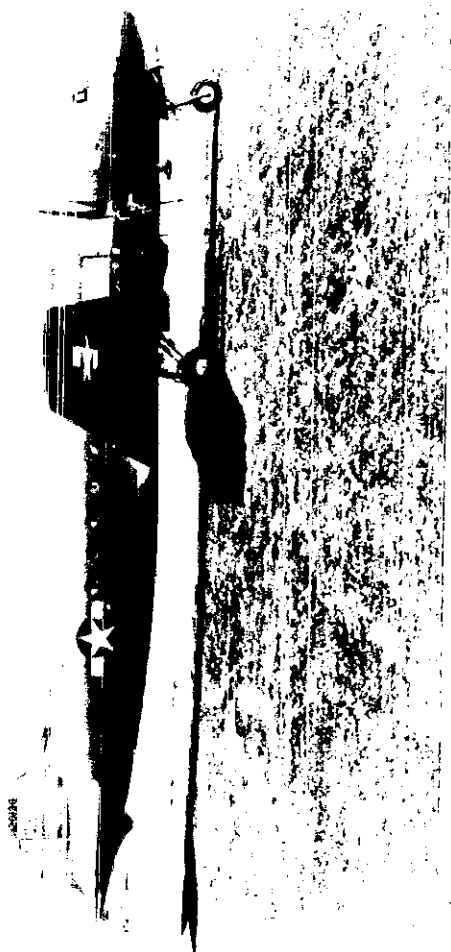

Figure 206①. The C-54.



Figure 206Ⓢ. Interior of the C-54 fitted to carry litter patients.

(5) Most heavy transport and cargo type aircraft carry from 18 to 28 litter patients. Litters are usually supported by standard web straps. The C-46 and C-47 are common types for use to evacuate patients from the evacuation hospital to the general hospital. The C-54 is a larger type aircraft which has admirably demonstrated suitability to evacuation of patients. It is used for long flights, usually transoceanic and will accommodate 20 to 36 patients. Many of these operate between the theaters of operations and the zone of the interior. Cargo aircraft capable of transporting much larger patient loads are in the process of development.

b. Requirements. The general type, number of engines, structural specifications, safety appliances, and flying instruments of the airplane come within the purview of the Army Air Forces. However, from the point of view of the arm or service charged with care and treatment of patients being transported, the following requirements are considered desirable:

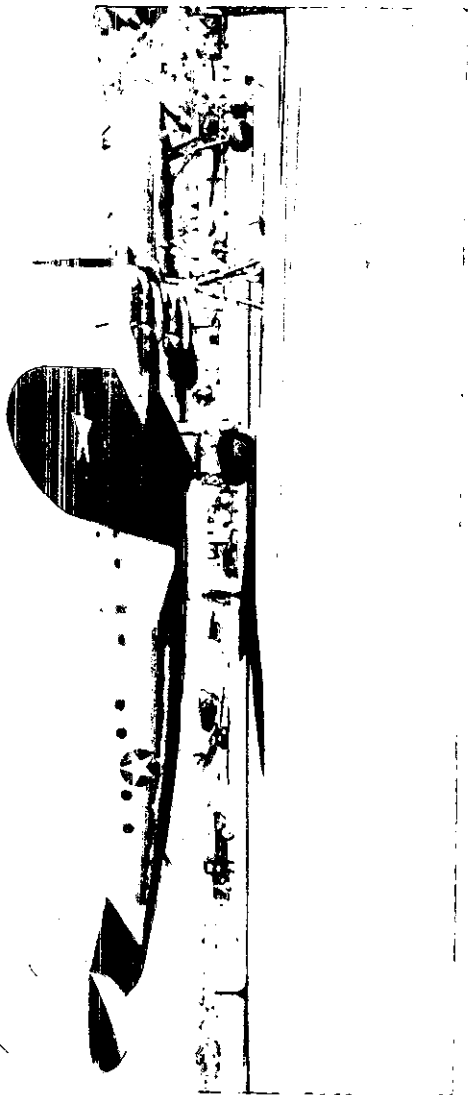

Figure 207①. The C-69.

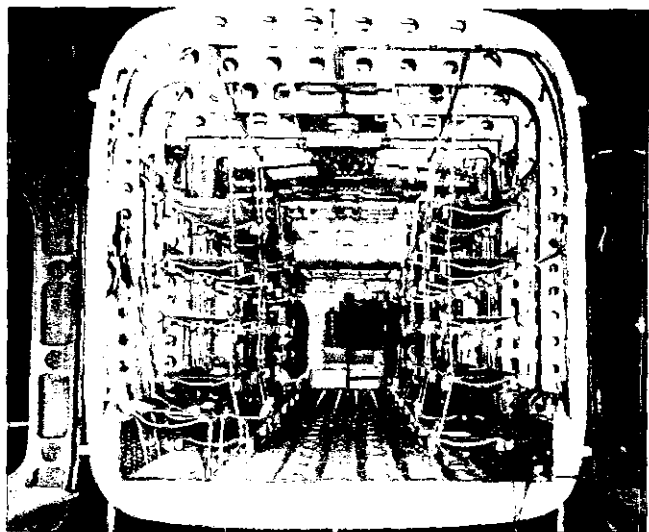

Figure 207Ⓢ. Interior of the C-82 fitted to carry 34 litter patients.

(1) *For all evacuation airplanes. (a) Cabins.* Regardless of the type of airplane, cabins should be equipped with heating and ventilating systems, doors of sufficient size to permit free entry of a loaded litter, and standard supports for the accommodation of standard United States Army Medical Department, British and Australian litters. Utilization of a standard litter precludes unnecessary movement of the patient incident to his evacuation. Strap supports are standard for all types of cargo aircraft.

(b) *Radio.* For liaison with ground personnel at loading and unloading points, inclusion of the radio in the equipment of the airplane is considered of vital necessity.

(c) *Medical equipment.* All airplanes will be equipped with apparatus for the administration of oxygen and

those items of medical importance such as plasma, drugs, etc., which are included in the Chest, airplane ambulance. Other medical equipment may be added as indicated.

(2) *For shuttle or light transport airplane.* Those airplanes plying within the combat zone should accommodate, in addition to the operating personnel, from 2 to 4 litter cases and 1 medical officer or enlisted attendant. Gasoline for more than 200 miles will seldom be required.

(3) *For heavy transport airplane.* All cargo airplanes convertible for evacuation of casualties should accommodate 18 or more litter cases and 2 medical attendants (1 flight nurse and 1 medical technician) in addition to the operating personnel.

c. *Sources.* Military transport airplanes utilized for evacuation purposes are equipped for quick conversion from cargo and personnel transport to patient transport.

106. UNITS FOR EVACUATION BY AIR. a. *Designation.* Units for the purpose of transporting sick and wounded are designated medical air evacuation squadrons. The number of such squadrons assigned to any given theater depends upon the requirements and the troop basis.

b. *Organization* (See T/O & E 8-447 and FM 8-5). The medical air evacuation squadron is a tactical unit of the Army Air Forces. It consists of a squadron headquarters (for command, administration, supply, mess, etc.) and four evacuation flights. Each flight consists of one flight surgeon with enlisted medical assistants, and six air transport teams. Each team consists of a flight nurse and an enlisted medical technician. This team ordinarily staffs one transport or cargo airplane, or, when advisable, may separate and staff two such airplanes. In the latter case the flight nurse accompanies the patients in more serious conditions. In an area in close proximity to the enemy, it may be considered unwise to utilize



Figure 208. Administration of plasma and oxygen aboard an ambulance plane.

the nurse for evacuation flights until the military situation becomes clarified. The medical air evacuation squadron has no airplanes as part of its organizational equipment. The medical air evacuation squadron, or a portion thereof, is attached for duty to an air force unit operating the type aircraft necessary for the evacuation mission to be carried out.

107. RESPONSIBILITIES FOR AIR EVACUATION UNITS. a. The Commanding General, Army Air Forces, is charged with the development and operation of air evacuation.

b. The Air Surgeon, under the Commanding General, AAF, is responsible for the supervision of the development and operation of air evacuation.

c. Within a theater, base command, or defense command, all units employed in air evacuation are a part of the air force of the theater, base, or defense command. The Medical Department units and the AAF units concerned with air evacuation, function as directed by the air force command or directly with troop carrier units of the air force. Plans for air evacuation within a theater, base, or defense command will be made by the air force surgeon, in coordination with the commander of the air units concerned, and the theater surgeon.

d. The Commanding General, AAF, is responsible for training units of the air forces and Medical Department for air evacuation missions. Troop carrier units of an air force in a task force perform air evacuation within a theater, base, or defense command.

e. Air evacuation from a theater, base, or defense command to the zone of interior is accomplished by the AAF Air Transport Command.

f. Air evacuation within continental United States is accomplished by the AAF Air Transport Command and by the local air facilities. The school of aviation medicine carries out a limited amount of domestic air evacuation for training purposes.

CHAPTER 8

WATER TRANSPORTATION

108. GENERAL. For transportation of the sick and wounded by water, any floating conveyance, depending upon its availability and feasibility, may be used.

109. WATER TRANSPORTATION, WHEN EMPLOYED. a. **Oversea operations.** Evacuation of the sick and wounded by means of water transportation is mandatory if a military force is operating in a theater separated from the zone of the interior by a large body of water. Under these circumstances, one of two situations may obtain, separately or one as an outgrowth of the other; these are joint Army and Navy oversea operation (FM 8-25) and separate Army oversea operation.

b. **River crossings.** In the event of a river crossing and the establishment of a bridgehead, evacuation of casualties by assault boats, rafts or cables will be necessary pending sufficient development of the situation to permit the construction and use of bridges.

c. **Airplane crashes.** Airplane crashes occurring over water demand rescue by boat in the absence of amphibian aircraft.

d. **Waterways within theater of operations.** Rivers, lakes, canals, or other bodies of water within the theater of operations, especially if they tend to be more or less perpendicular to the front, may become an important link in the chain of evacuation if suitable craft is available.

110. CARGO OR TRANSPORT SHIPS. a. **Cargo** (fig. 209) or transport ships, although possessing no special

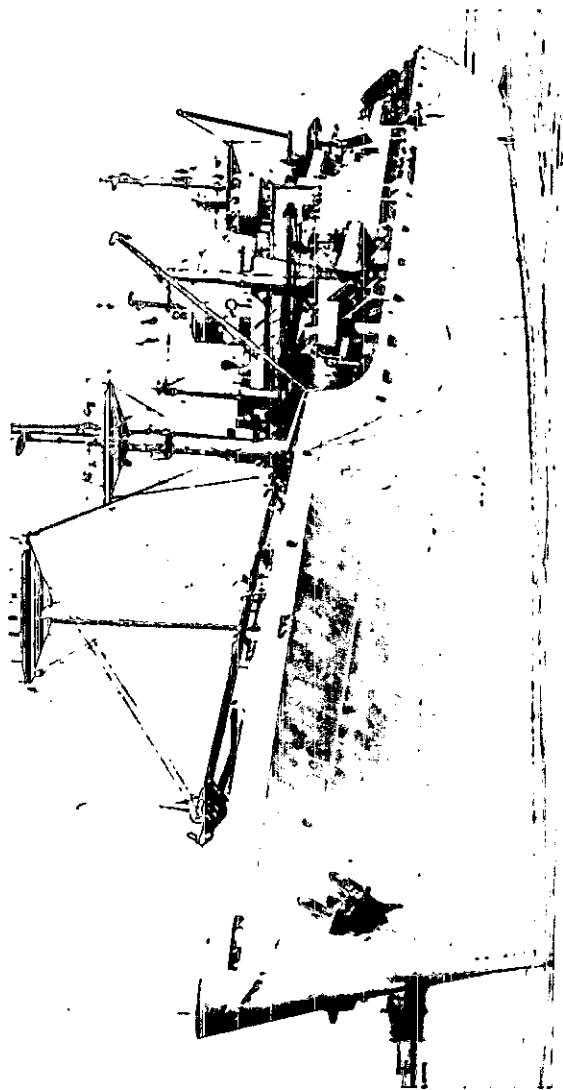

Figure 209. A cargo ship of the type suitable for use as a patient carrier.

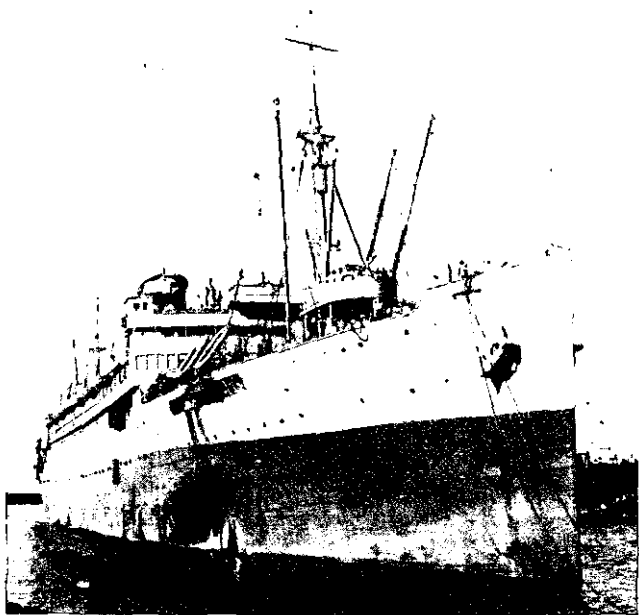

Figure 210. A troop transport of the type suitable for use for transportation of casualties.

hospital facilities other than those of any transport, may be utilized, on the return trip to the port of embarkation, to evacuate casualties from a theater of operations. Since the primary use of such ships is not medical, they cannot be protected by the Geneva Convention. One or more medical hospital ship platoons, separate, will be assigned when patients are transported (FM 8-5) to supplement the ship's normal medical personnel.

b. Some cargo and transport ships (fig. 210) are used primarily for medical purposes, but also used on outbound trips for troops and cargo. These ships evacuate casualties from the theater of operations to the zone of the interior. They have special medical facilities, such



Figure 211. The hospital ship, St. Mihiel.



Figure 212. Ward of a hospital ship.

as surgical, medical, X-ray, and dental sections. They are staffed by medical ambulance ship companies (FM 8-5) which, although not permanent complements, may remain with the ships over several round trips. Such ships are armed, and are not protected by the Geneva Convention.

111. HOSPITAL SHIPS. a. Hospital ships (fig. 211). Hospital ships are used only to transport sick and wounded patients. They must conform to the following provisions of the Hague and Geneva Conventions to enjoy immunity from attack:

(1) The painting will be distinctive, and in conformity with current international agreement.

(2) The Red Cross flag will be flown.

(3) The vessel will be announced to the enemy prior to its employment.

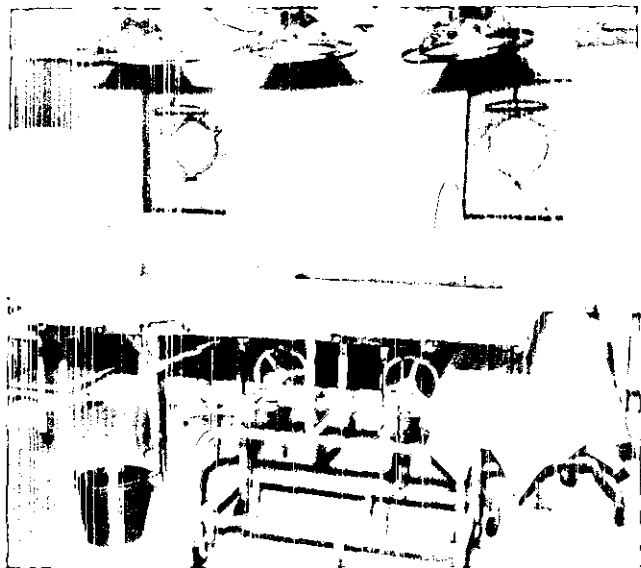

Figure 213. Operating room of a hospital ship.

(4) It will be manned and staffed by noncombatant personnel.

(5) It will not be employed for any military or unneutral purpose such as the transportation of armed forces, military supplies, or military communications.

b. Personnel and facilities. (1) The hospital ship is staffed by a hospital ship complement (FM 8-5). This unit provides the medical service of the ship, and corresponds roughly to the staff of a station hospital. The ship itself may operate as a hospital, providing definitive treatment during the early stages of landing operations, or it may act as an ambulance ship transporting patients from the theater of operations to the zone of the interior.

(2) The hospital ship will have all the medical facilities of a well-equipped hospital, including wards, operat-



Figure 214. Improvised litter racks on small landing craft (Australian maneuvers).

ing rooms, X-ray room, pharmacy and laboratory, dental section, etc. (See figs. 212 and 213.)

c. Selection of vessels for hospital transports. Within the limits of availability, commercial vessels for conversion and employment as hospital transports should be selected with the following points receiving careful consideration:

(1) *Type.* Because of the relative adequacy of messing, fresh water, laundry, latrine, and other important facilities, types of vessel, in order of preference, are passenger, combination passenger and cargo, and cargo.

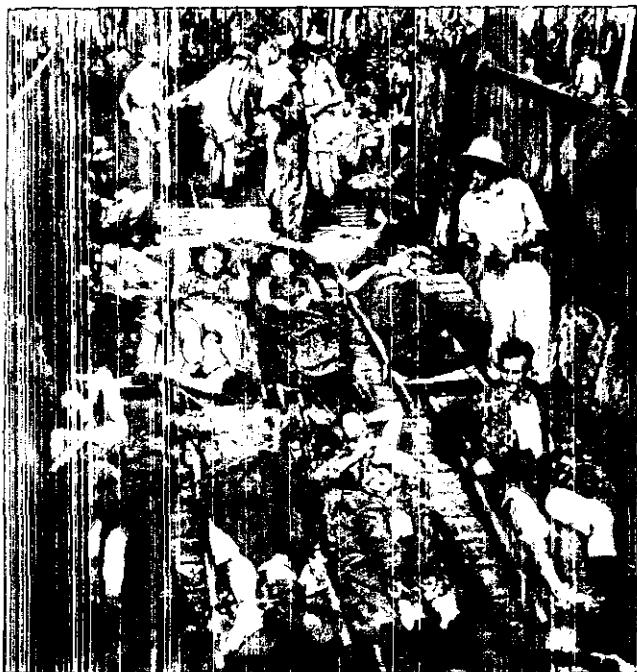
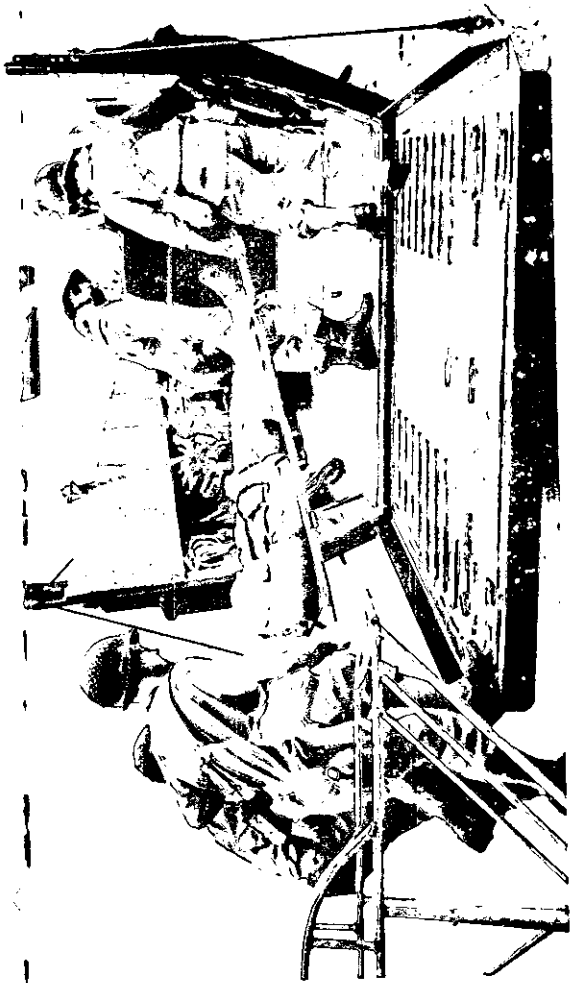

Figure 215. Casualties being evacuated by lighter
(New Georgia).

(2) *Means of propulsion.* Unless the availability of fuel is a pertinent factor, engines utilizing oil rather than coal are preferable. The type engine and the number of propellers should be investigated with a view to reducing noise and vibration to a minimum. Fuel storage space must be commensurate with the desired cruising radius.

(3) *Size.* Unless the duty to be performed and the distance to be traversed dictate otherwise, a vessel of about 10,000 tons, capable of transporting from 350 to 500 patients after conversion, is preferable. Larger vessels have difficulty in entering small harbors and estuaries;



*Figure 216. Loading small landing craft by hand
(Australian maneuvers).*

supplying their fuel and water becomes more difficult; and, with less than a full load of patients, employment will be uneconomical.

(4) *Speed.* If not immune to enemy attack, a hospital transport should be capable of equalling the speed of the train or convoy accompanying it. If immune, the speed should be commensurate with the distance to be traversed. Other factors being normal, a cruising speed of 15 knots with a few knots reserve is most satisfactory. Greater speed increases vibration and decreases the cruising radius.

(5) *Steadiness.* The comfort of patients is influenced to a marked degree by the steadiness of the vessel and this factor, which varies even in similar craft, should be determined prior to selection.

(6) *Odors and infestation.* Due to the difficulty of complete eradication, vessels which have been infested recently with insects or vermin should be avoided.

112. LOADING SHIPS OR SMALL CRAFT. a. **At docks.** When the tactical situation permits, ships employed for water evacuation will be loaded at suitable ports. Since ports are natural targets of enemy aerial bombardment, ships must be loaded and cleared as rapidly as possible. Patients are carried aboard ship from ambulances by litter squads, or may be loaded by Stokes litter (fig. 42) or loading box (fig. 217) and the ship's hoist.

b. **Offshore.** Often, especially in the initial phases of a landing operation, there will be no port facilities available for the loading of evacuation ships. In such circumstances hospital ships will approach as close to shore as possible, where they will be loaded. Any type of landing craft may be used to transport patients from the shore to the ship. Since landing craft carry combat troops and materiel on their shoreward trips, they are objects of hostile attack. Therefore when used for patient evacuation they must be loaded and en route with all possible



Figure 217. Loading large landing craft (LST) by use of loading box (France).

speed. Patients may be placed flat on the decks of the craft (fig. 215) or litter racks may be improvised (fig. 214). Small craft will be loaded by hand (fig. 216) while some sort of loading box will facilitate greatly the loading of larger craft (fig. 217). After small landing craft have made their voyage from shore to ship, litter patients can best be transferred to the ship by means of loading boxes (fig. 218) or Stokes litters.

113. CROSSING RIVERS, LAKES, AND OTHER SMALL BODIES OF WATER. a. General. It will often be necessary, especially in offensive operations, to devise some method of crossing rivers, lakes, and other small bodies of water that may become barriers in the evacuation of casualties. In the early stages of attack, pontoon and other bridges are generally used exclusively by forward-moving troops, so that rear-ward traffic must construct its own means of stream crossing.

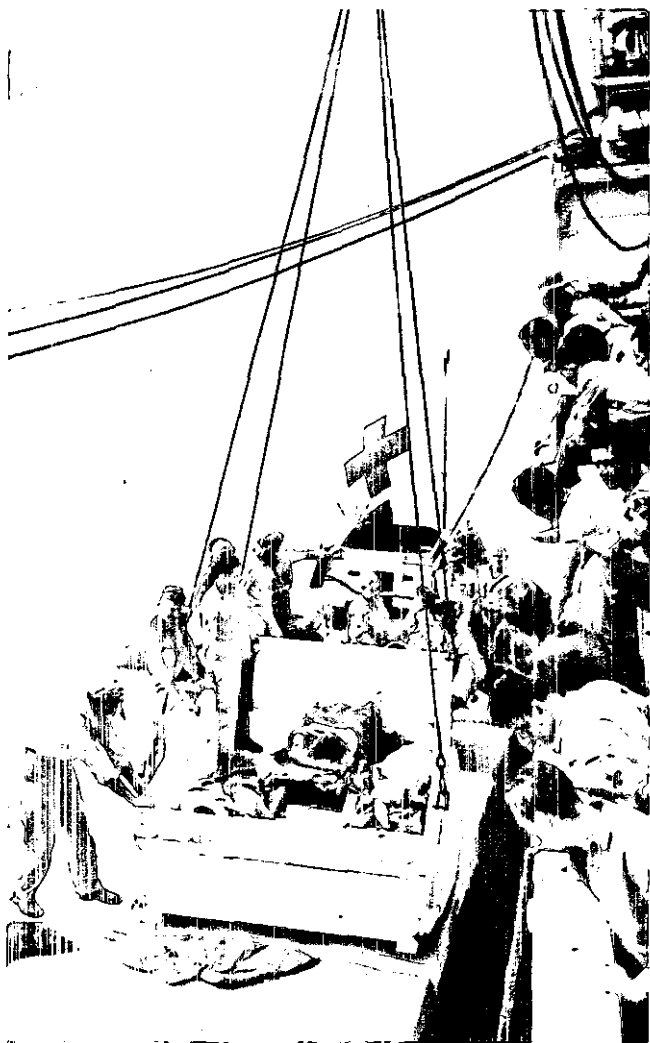

Figure 218. Use of loading boxes to transfer patients from landing craft to ship (area unidentified).



Figure 219. Assault boat used to evacuate casualties across stream.

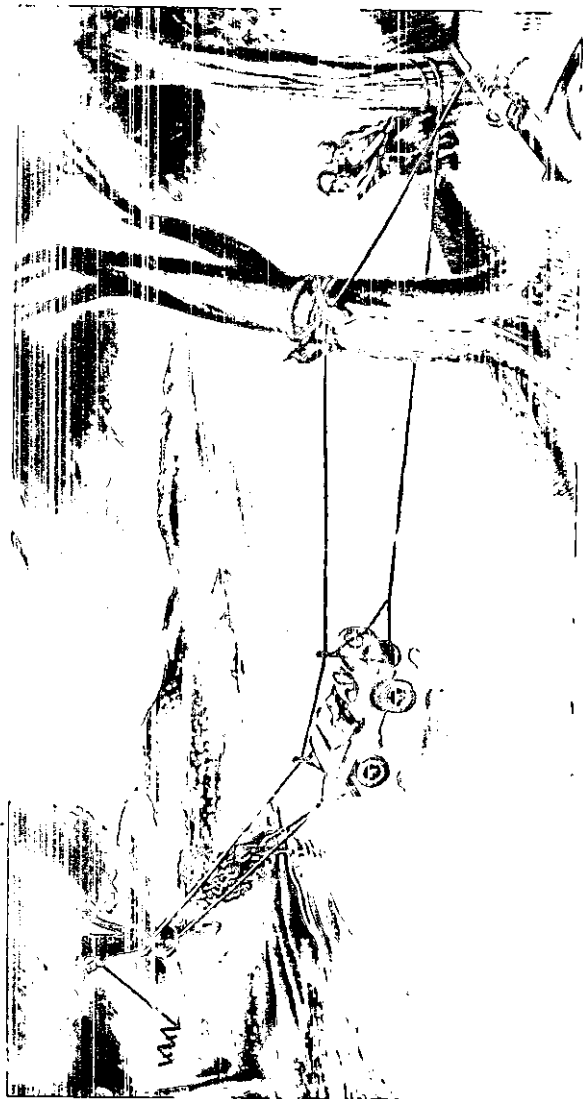

Figure 220. Method of rigging cable of 2 1/4-ton winch truck across stream to carry small vehicles or litter platforms.

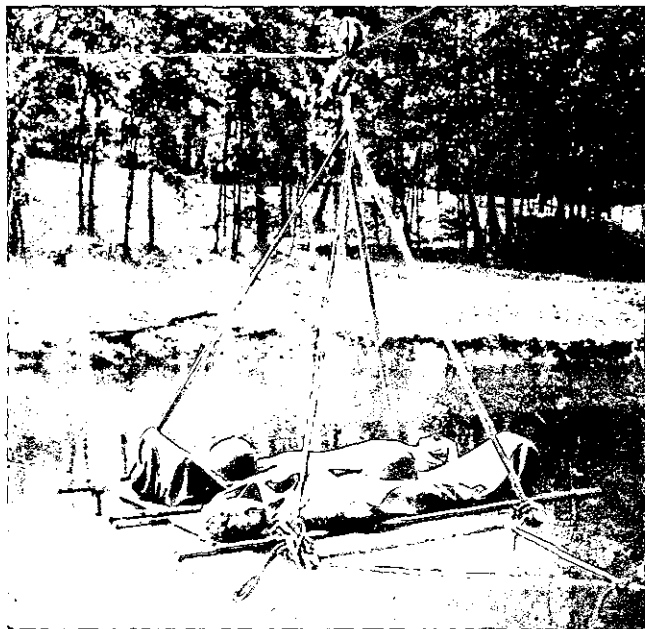

Figure 221. Litters being pulled across stream by cable method.

b. **Assault boats** (fig. 219). Engineer assault boats, when available, are readily adaptable to the needs of medical troops. Two litter casualties can be placed lengthwise in the bottom of the boat, and four above them crosswise, handles resting on the gunwales, with their stirrups just inside the boat holding litters in place. Room is thus provided in the bow and stern for medical and engineer personnel to paddle the boat.

c. **Cables** (fig. 220). Two litter casualties can be transported across a stream in the following manner: the cable of a 2½-ton winch truck is strung through a pulley, above and across the stream, and fastened to a tree or other holding device on the opposite shore. A

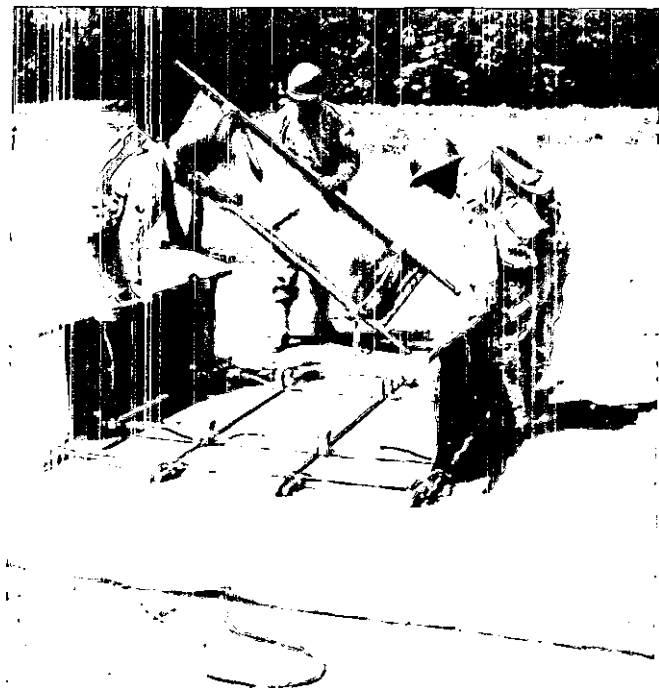

Figure 222. Construction of litter and paulin raft.

second pulley runs free along the cable. Suspended from this second pulley by ropes are two saplings, poles, or other appropriate objects of the width of two litters. The litters rest upon these poles, the litter stirrups just inside the poles and holding them in position. Personnel on the two shores control the crossing by two ropes, the man on the near shore pulling the litters across and the man on the far shore maintaining control by holding them back when necessary. When the litters have crossed, patients or patients plus litters are removed, the device pulled back to the other side, and two more casualties sent across. The entire apparatus can be erected in less



Figure 223. Crossing stream by means of litter and paulin raft.

than one half hour, uses equipment readily available to medical troops, and once constructed permits an uninterrupted flow of litter casualties across the stream. Due to the length of the cable, this method is limited to bodies of water less than .200 feet in width.

d. **Litter and paulin raft** (figs. 222 and 223). A raft may be constructed of seven litters and the paulin from a 2½-ton truck. The paulin is spread open on the ground and three litters laid, stirrups up, in its center. The other four litters are placed on their sides to form the basis of the four walls of the raft, their handles interlocking and lashed together with lengths of rope. The sides of the paulin are then lifted and folded over the four litters and tied in place, thus completing the raft walls. This raft will accommodate two litter patients plus escort, is very stable, and can be crossed by paddling or by being pulled. It can be constructed in 15 minutes by untrained men under proper direction.